



CARIBBEAN EXAMINATIONS COUNCIL

# CSEC<sup>®</sup> Technical Drawing

SYLLABUS  
SPECIMEN PAPER  
MARK SCHEME  
SUBJECT REPORTS

Macmillan Education  
4 Crinan Street, London, N1 9XW  
A division of Macmillan Publishers Limited  
Companies and representatives throughout the world

[www.macmillan-caribbean.com](http://www.macmillan-caribbean.com)

ISBN 978-0-230-48177-0 AER

© Caribbean Examinations Council (CXC®) 2015  
[www.cxc.org](http://www.cxc.org)  
[www.cxc-store.com](http://www.cxc-store.com)

The author has asserted their right to be identified as the author of this work in accordance with the Copyright, Design and Patents Act 1988.

First published 2014

This revised version published 2015

**Permission to copy**

The material in this book is copyright. However, the publisher grants permission for copies to be made without fee. Individuals may make copies for their own use or for use by classes of which they are in charge; institutions may make copies for use within and by the staff and students of that institution. For copying in any other circumstances, prior permission in writing must be obtained from Macmillan Publishers Limited. Under no circumstances may the material in this book be used, in part or in its entirety, for commercial gain. It must not be sold in any format.

Designed by Macmillan Publishers Limited  
Cover design by Macmillan Publishers Limited and Red Giraffe

## **CSEC® Technical Drawing Free Resources**

### **LIST OF CONTENTS**

CSEC® Technical Drawing Syllabus Extract 4

CSEC® Technical Drawing Syllabus 5

#### **CSEC® Technical Drawing Specimen Papers:**

Paper 01 Specimen Paper 86

Paper 02 (Mechanical Engineering Drawing) Specimen Paper 104

Paper 02 (Building Drawing) Specimen Paper 114

#### **CSEC® Technical Drawing Mark Schemes:**

Paper 01 -Mark Scheme for SP 102

Paper 02 (Mechanical Engineering Drawing) -Mark Scheme for SP 109

Paper 02 (Building Drawing) -Mark Scheme for SP 118

#### **CSEC® Technical Drawing Subject Reports:**

2009 Subject Reports 123

2010 Subject Report 133

2011 Subject Report 142

2013 Subject Report 153

2014 Subject Report 167

2015 Subject Report 178

# Technical Drawing

Technical Drawing is a visual means of communicating clearly and concisely all the information (drawings, dimensions, notes, specifications) necessary to transfer an idea or concept into reality. It is based on the principles of projection in two-dimensional and three-dimensional representations. Technical Drawing plays an indispensable role in determining the quality and competitiveness of finished products in the design process. It is, therefore, an important prerequisite and an essential companion for the CSEC Industrial Technology programmes which provide the foundational competencies in manufacturing and industrialisation in the Caribbean.

The syllabus focuses on the development of competencies in geometric construction, descriptive geometry, engineering designs and graphics, electrical, mechanical, manufacturing and construction drafting. These are geared toward the development of students' spatial visualisation, technical communication, interdisciplinary and employability skills. These skills are useful for careers in drafting, architecture, surveying, civil engineering, interior designing, design engineering and in the general construction and manufacturing industries. In addition, the programme of studies in the syllabus caters for those students who will seek entry level employment in related fields.

The syllabus is divided into four (4) Sections:

SECTION 1 - Fundamentals of Technical Drawing

SECTION 2 - Geometrical Construction  
(a) Plane Geometry  
(b) Solid Geometry

SECTION 3 - Building Drawing

SECTION 4 - Mechanical Engineering Drawing

Candidates are expected to undertake SECTION 1: Fundamentals of Technical Drawing, SECTION 2: Geometrical Construction and **EITHER** SECTION 3: Building Drawing **OR** SECTION 4: Mechanical Engineering Drawing.



**CARIBBEAN EXAMINATIONS COUNCIL**

**Caribbean Secondary Education Certificate®**

**CSEC®**

# **TECHNICAL DRAWING SYLLABUS**

**Effective for examinations from May–June 2017**

Published by the Caribbean Examinations Council

© 2015, Caribbean Examinations Council

All rights reserved. No part of this publication may be reproduced, stored in a retrieval system, or transmitted in any form, or by any means electronic, photocopying, recording or otherwise without prior permission of the author or publisher.

Correspondence related to the syllabus should be addressed to:

The Pro-Registrar  
Caribbean Examinations Council  
Caenwood Centre  
37 Arnold Road, Kingston 5, Jamaica, W.I.

Telephone Number: +1 (876) 630-5200

Facsimile Number: +1 (876) 967-4972

E-mail Address: [cxcwzo@cxc.org](mailto:cxcwzo@cxc.org)

Website: [www.cxc.org](http://www.cxc.org)

Copyright © 2015 by Caribbean Examinations Council  
Prince Road, Pine Plantation Road, St Michael BB11091



This document CXC 13/G/SYLL/ 15 replaces CXC 13/G/SYLL 10 issued in 2010.

Please note that the syllabus has been revised and amendments are indicated by italics.

First issued 2000

Revised 2010

Revised 2015

Please check the website, [www.cxc.org](http://www.cxc.org) for updates on CXC's syllabuses.



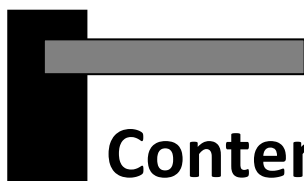

# Contents

RATIONALE .....	1
AIMS.....	2
ORGANISATION OF THE SYLLABUS .....	2
RECOMMENDED TEACHING APPROACH.....	2
SUGGESTED TIMETABLE ALLOCATION .....	3
CERTIFICATION.....	3
DEFINITION OF PROFILE DIMENSIONS.....	4
<i>CERTIFICATION AND DEFINITION OF PROFILE</i> .....	4
<i>FORMAT OF THE EXAMINATION</i> .....	4
WEIGHTING OF PAPERS AND PROFILES .....	5
COMPOSITION OF PAPERS BY SECTIONS .....	6
REGULATIONS FOR PRIVATE CANDIDATES .....	6
REGULATIONS FOR RESIT CANDIDATES .....	6
RECOMMENDED MINIMUM EQUIPMENT AND MATERIAL FOR TECHNICAL DRAWING SYLLABUS .....	7
COMPUTER-AIDED DRAFTING METHOD .....	7
<i>SECTION 1 – FUNDAMENTALS OF TECHNICAL DRAWING</i>	
<i>1A – OCCUPATIONAL HEALTH, SAFETY AND THE ENVIRONMENT</i> .....	9
<i>SECTION 1B – EQUIPMENT, TOOLS, MATERIALS, LETTERING, LINE WORK, DIMENSIONS AND SCALES)</i> .....	13
<i>SECTION 2A – GEOMETRICAL CONSTRUCTION: PLANE GEOMETRY</i> .....	20
<i>SECTION 2B – GEOMETRICAL CONSTRUCTION: SOLID GEOMETRY</i> .....	26
<i>SECTION 3A – BUILDING DRAWING</i> .....	32



SECTION 4 – MECHANICAL ENGINEERING DRAWING .....	40
SUGGESTED TEACHING AND LEARNING ACTIVITIES .....	50
GUIDELINES FOR THE SCHOOL-BASED ASSESSMENT .....	51
SUGGESTED ACTIVITIES FOR THE SBA .....	52
EXEMPLARS .....	55
RESOURCES .....	65
GLOSSARY OF TERMS .....	66
APPENDIX I – SCHOOL-BASED ASSESSMENT MARK SCHEME.....	68
APPENDIX II – PORTFOLIO DEVELOPMENT GUIDELINES .....	73
APPENDIX III – GUIDELINES FOR THE DELIVERY AND ASSESSMENT OF THE SCHOOL-BASED ASSESSMENT USING THE PRINCIPLES OF COMPETENCY-BASED EDUCATION, TRAINING AND ASSESSMENT (CBETA) .....	75
SPECIMEN PAPERS.....	77



# Technical Drawing Syllabus

## ◆ RATIONALE

*Technical Drawing is a visual means of communicating clearly and concisely all the information (drawings, dimensions, notes, specifications) necessary to transfer an idea or concept into reality. It is based on the principles of projection in two-dimensional and three-dimensional representations. Technical Drawing has its most common application in the field of manufacturing, engineering, architecture and construction where it is used to document and support the design process. This is accomplished by communicating ideas about the shape, form, dimensions, materials, manufacturing methods and finishes of articles to be produced. Technical Drawing plays an indispensable role in determining the quality and competitiveness of finished products in the design process. It is, therefore, an important prerequisite and an essential companion for the CSEC Industrial Technology programmes which provide the foundational competencies in manufacturing and industrialisation in the Caribbean.*

*The syllabus focuses on the development of competencies in geometric construction, descriptive geometry, engineering designs and graphics, electrical, mechanical, manufacturing and construction drafting. These are geared toward the development of students' spatial visualisation, technical communication, interdisciplinary and employability skills. These skills are useful for careers in education, drafting, architecture, surveying, engineering (robotics, fabrication and civil), interior, spacial and structural, engineering designing, and in the general construction and manufacturing industries. In addition, the programme of studies in the syllabus caters for those students who will seek entry level employment in related fields.*

*The formulation of the syllabus takes into consideration the development of selected attributes of the Ideal Caribbean Person as documented in the 2000 Caribbean Education Strategy. This person is one who is emotionally secure with a high level of self-confidence and self-esteem; is aware of the importance of living in harmony with the environment; demonstrates multiple literacies, independence and critical thinking; values and displays the creative imagination in its various manifestations and nurtures its development in the economic and entrepreneurial spheres in all other areas of life.*

*The Technical Drawing syllabus integrates the principles of Competency Based Education, Training and Assessment (CBETA) in the School-Based Assessment component. This strategy is consistent with the seamless articulation among CXC's qualifications to facilitate an appropriate balance between the academic and technical subjects and to improve work-based performance. These competencies align with the UNESCO Pillars of Learning – learning to know, learning to do, learning to live together, learning to be and learning to transform one's self and society.*

## ◆ AIMS

The syllabus aims to:

1. enable students to acquire an understanding of the relationship of design and drawing in manufacturing and industrialisation;
2. provide students with the competencies required for understanding, interpreting and producing technical drawings aligned with established standards, conventions and technology;
3. develop students' critical thinking, quality standards and teamwork skills in the production of drawings using traditional methods or design software packages;
4. develop students' appreciation of creativity, imagination and aesthetics in designs and drawings;
5. provide students with foundation competencies in entrepreneurial skills for employment creation and economic development.

## ◆ ORGANISATION OF THE SYLLABUS

The syllabus is divided into four (4) Sections:

SECTION 1 - Fundamentals of Technical Drawing

- (a) Occupational Health, Safety and the Environment.
- (b) Equipment, Tools, Materials, Lettering, Line Work, Dimensions and Scales.

SECTION 2 - Geometrical Construction

- (a) Plane Geometry.
- (b) Solid Geometry.

SECTION 3 - Building Drawing

SECTION 4 - Mechanical Engineering Drawing

Candidates are expected to undertake SECTION 1: Fundamentals of Technical Drawing, SECTION 2: Geometrical Construction and **EITHER** SECTION 3: Building Drawing **OR** SECTION 4: Mechanical Engineering Drawing.

## ◆ RECOMMENDED TEACHING APPROACH

In developing the plan to deliver and assess the syllabus, the teacher is asked to carefully note the areas of the syllabus that overlap with the Units of Competence in the Regional Occupational

*Standards. These Units of Competence are tied to the SBA component and should be delivered and assessed concurrently.*

*The teacher is encouraged to combine institutional and industry training (dual) to facilitate students learning. Students are to be exposed to a wide range of activities that will allow them to have authentic learning experiences. This may be facilitated through projects, field studies, industry attachment, partnerships with National Training Agencies and the use of simulators and/or other virtual activities.*

## ◆ SUGGESTED TIMETABLE ALLOCATION

It is recommended that a minimum of six 40-minute periods per week, *over two academic years* or the equivalent be allocated to the syllabus. Single periods are not recommended.

### ALLIED SUBJECTS

Candidates should be encouraged to include the following subjects in their programme of study: One of the Industrial Technology subjects (Building Technology; Mechanical Engineering Technology; Electrical and Electronic Technology), English A, Mathematics, Physics.

## ◆ CERTIFICATION

The Technical Drawing course is an integral component of the Technical and Vocational Education and Training (TVET) programme offered by the Council. *It will be examined for certification at Technical Proficiency. A candidate's performance will be indicated on the certificate by an overall numerical grade on a six-point scale as well as a letter grade for each of three profile dimensions, namely, Knowledge, Application and Practical Ability. Candidates have the option of using either the Traditional Drawing Method (drawing board and tee square) or Computer-Aided Drafting (CAD) method/applications.*

*The School-Based Assessment component for this syllabus is aligned to selected Units of Competence within the regional qualification of the Caribbean Vocational Qualification (CVQ). Through this integration every student with acceptable grades, where applicable may exit with recognition of competencies for the drawing unit from the Level 1 Caribbean Vocational Qualification (CVQ) in:*

1. *General Construction (CCBCG10102), Draw and interpret simple drawings (BCGCOR0031A);*
2. *Furniture Making (CCLMF10103), Read and interpret work documents (LMFCOR0071A);*
3. *Electrical Installation (CCMEM11002), Draw and interpret sketches and simple drawings (MEMCOR0091A); or,*
4. *Metal Work Engineering (CCMEM10302), Draw and interpret sketches and simple drawings (MEMCOR0091A).*

*The decisions to award competencies will be based on the quality and relevance of the evidences presented to the occupational area.*



## ◆ DEFINITION OF PROFILE DIMENSION

*On completion of the syllabus, in addition to the overall grade, candidate performance will be reported under the following profile dimensions:*

1. Knowledge;
2. Application;
3. Practical Ability.

### **Knowledge**

*The ability to:*

*recall and comprehend terms, principles, methods, theories and structures.*

### **Application**

*The ability to:*

1. *use concepts, principles, methods and theories to solve problems in a given situation;*
2. *analyse, synthesise and evaluate; interpret and extrapolate.*

### **Practical Ability**

*The ability to:*

*demonstrate manipulative skills involving the use of Computer-Aided Drafting methods, drawing instruments, equipment and materials in problem solving situations.*

## ◆ FORMAT OF THE EXAMINATION

### **EXTERNAL ASSESSMENT**

#### **Paper 01** (1 ¼ hours)

*This paper will consist of 60 multiple-choice items, focusing on Section 1 (Fundamentals of Technical Drawing) and Section 2 (Geometrical Construction – Plane & Solid Geometry).*

*On this paper, Knowledge, Application and Practical Ability will be tested. Each item will be worth one mark.*

*This paper will represent 60 marks (20 per cent) of the total score.*

**Paper 02**  
(2 hours)

*This paper will consist of two compulsory structured questions. There are **two separate papers**, one for Mechanical Engineering Drawing and one for Building Drawing.*

*Question 1 will be worth 90 marks of which 18 will be for Knowledge, 36 for Application and 36 for Practical Ability.*

*Question 2 will be worth 30 marks of which 6 will be for Knowledge, 11 for Application, and 13 for Practical Ability.*

*This paper will contribute 120 marks (40 per cent) to the total score.*

*The CSEC External Assessment will contribute 180 marks (60 per cent) to the total score.*

**Paper 03**

The SBA assessment will contain:

- One piece from Section 1 (Specific Objectives 1 to 10) and Section 2 (Specific Objectives 1 and 2). This is a written question.
- Two pieces from Section 2 (Plane Geometry and Solid Geometry).
- The projects from Section 3 or Section 4.

**WEIGHTING OF PAPERS AND PROFILES**

*The table below shows the marks assigned to each component of the assessment, and to each profile and the percentage contribution of each paper to the total score.*

**Table 1 – Percentage of Weighting of Papers and Profiles**

<b>PAPERS</b>	<b>KNOWLEDGE</b>	<b>APPLICATION</b>	<b>PRACTICAL ABILITY</b>	<b>TOTAL RAW</b>	<b>Weighting</b>
<b>EXTERNAL ASSESSMENT</b> <b>Paper 01</b> <i>Multiple Choice questions</i>	<b>30</b>	<b>24</b>	<b>6</b>	<b>60</b>	20%
<b>Paper 02</b> <i>Structured Questions</i>	<b>24</b>	<b>47</b>	<b>49</b>	<b>120</b>	40%
<i>Question 1</i>	18	36	36	90	
<i>Question 2</i>	6	11	13	30	
<b>SCHOOL-BASED ASSESSMENT</b> <b>Paper 03</b> <i>SBA Portfolio of Evidence</i>	<b>15</b>	<b>34</b>	<b>71</b>	<b>120</b>	40%
	<b>69</b>	<b>105</b>	<b>126</b>	<b>300</b>	100%

## **COMPOSITION OF PAPERS BY SECTIONS**

The table below shows the composition of the papers by sections.

**Table 2 – Composition of Papers by Sections**

<b>ASSESSMENT</b>	<b>Section 1</b> <i>Fundamentals of Drawing</i>	<b>Section 2</b> <i>Geometrical Construction</i>	<b>Section 3</b> <i>Building Drawing</i>	<b>Section 4</b> <i>Mechanical Engineering Drawing</i>
<b>EXTERNAL ASSESSMENT</b> <i>Paper 01</i> <i>Multiple Choice questions</i>	✓	✓		
<i>Paper 02</i> <i>Structured Questions</i>	✓	✓	✓	✓
<b>SCHOOL- BASED ASSESSMENT</b> <i>Paper 03</i> <i>SBA Portfolio of Evidence</i>	✓	✓	✓	✓

### ◆ **REGULATIONS FOR PRIVATE CANDIDATES**

Candidates who do not attend school full-time may undertake the course as a private candidate. A private candidate is one not entered through a school or other approved educational institution.

Such a candidate must observe the following guidelines:

1. complete *all the components of the examination*;
2. identify a teacher/tutor from a registered institution (school/technical institute/community college) who will assess and approve the candidate's submission for the School-Based Assessment component of the syllabus; and,
3. submit the name, school, and territory of the identified teacher/tutor to the Council on registration for the subject.

### ◆ **REGULATIONS FOR RESIT CANDIDATES**

*Resit candidates must rewrite Papers 01 and 02 of the examination for the year in which they re-register. However, resit candidates who have earned a moderated score 50 per cent or more of the maximum score for the School-Based Assessment component may elect not to repeat this component, provided they rewrite the examination no later than 2 years immediately following their first attempt.*

*Resit candidates who have obtained a moderated score of less than 50 per cent of the maximum score for the School-Based Assessment component must repeat the component at any subsequent sittings. Resit candidates may enter through schools, recognised educational institutions or the Local Registrar's Office.*



## ◆ RECOMMENDED MINIMUM EQUIPMENT AND MATERIAL FOR TECHNICAL DRAWING SYLLABUS

### TRADITIONAL DRAWING METHOD (For a Class of 20)

Any suitable classroom can be converted into a Drawing Room with the addition of Drawing Boards.

	EQUIPMENT	QUANTITY
1.	Drawing boards	20
	<b>OR</b>	
	Dual drawing desks	10
	<b>OR</b>	
	Drawing tables	20
2.	Half imperial tee-squares	20
3.	Pair of set squares	20
4.	Protractors, scales and French curves	20
5.	Templates	20
6.	Set of drawing instruments	20

In addition, students will be required to have the following:

7. a hand towel or cheese cloth;
8. a good eraser;
9. pencil – grades HB, F, H 2H.

### **COMPUTER-AIDED DRAFTING METHOD (For a Class of 10)**

*It is the responsibility of schools that select the Computer-Aided Drafting option to ensure that the required hardware and software are in place to achieve the objectives of the syllabus.*

	<b><u>Recommended Hardware</u></b>	<b><u>Quantity</u></b>
1.	PC fitted with an Intel 80486 or Pentium CPU with the following features: (a) a 17 inch monitor; (b) mouse; and (c) keyboard	10
2.	Laser Printer/Plotter	1
3.	UPS/other power protection devices	1

### **Recommended Software**

*Computer-Aided Drafting software package offering the advanced features required to complete the syllabus objectives.*





**NB:** *The School Edition of the software package selected should be purchased to facilitate its (legal) use on multiple computers.*

**NOTES TO TEACHERS/FACILITATORS – COMPUTER-AIDED DRAFTING (CAD)**

1. *Students should be encouraged to undertake a basic computer literacy course.*
2. *The Computer-Aided Drafting (CAD) application mentioned in this section should be covered by teachers/facilitators and students to achieve the objectives of this syllabus. Those that are mentioned are not exhaustive in covering all the required operations and functions available within a CAD programme.*

*The sequence mentioned is just a suggestion to teachers/facilitators. Teachers are, however, encouraged to develop their own sequential order.*

3. **SUGGESTED OPERATIONS**

- (a) *Launch CAD programme.*
- (b) *Set unit and limits.*
- (c) *Set layers.*
- (d) *Locate and use tool bars, i.e. dimensions, draw, layers, modify, text, zoom, viewport, standard, properties.*
- (e) *Status bar, such as snap, polar, ortho, grid, OSNAP, otracking, lineweight, model and paper space.*
- (f) *Use of command lines, keyboards.*
- (g) *Dimensioning.*
- (h) *Viewports, scales and scale factors.*
- (i) *Save file.*
- (j) *Print/plot.*

## ◆ SECTION 1: FUNDAMENTALS OF TECHNICAL DRAWING

### 1A: OCCUPATIONAL HEALTH, SAFETY AND THE ENVIRONMENT

#### GENERAL OBJECTIVES

On completion of this Section, students should:

1. demonstrate a working knowledge of safety and maintenance standards governing workshop/laboratory and the use of drawing equipment and materials; and,
2. develop an awareness of safety and occupational health hazards and their preventative procedures and practices.

#### SPECIFIC OBJECTIVES

Students should be able to:

1. discuss safety, health and welfare standards for the technical drawing workshop/laboratory;
2. develop safety, health and welfare requirements governing workshop/laboratory;
3. classify safety resources for specific operations;
4. classify the different types of fires and fire-fighting equipment;
5. use a fire extinguisher;
6. differentiate among accident, injury and emergency;
7. apply basic First Aid principles and practices;
8. explain how to get professional help when an accident occurs;
9. identify hazards and hazardous substances; and,
10. perform mock drills for emergencies.

#### CONTENT

1. **Safety, health and welfare standards**
  - (a) Standards for:
    - (i) workshop/laboratory;
    - (ii) equipment; and,
    - (iii) materials.



## **1A: OCCUPATIONAL HEALTH, SAFETY AND THE ENVIRONMENT (cont'd)**

(b) *Occupational Health and Safety (OHS).*

(c) *Guidelines for:*

(i) *working safely;*

(ii) *enhancing wellness; and,*

(iii) *preventing injury and accident.*

### **2. Safety, health and welfare requirements**

(a) *Inventory of materials, tools and equipment.*

(b) *Workshop/laboratory and equipment maintenance plans.*

(c) *Workshop/laboratory layout and shop organisation diagrams.*

(d) *List of danger points.*

(e) *Safety signs and symbols.*

(f) *Safety lanes.*

(g) *Personal Protective Equipment (PPE).*

(h) *Equipment guards.*

### **3. Safety resources**

(a) *PPE:*

(i) *for different tasks; and,*

(ii) *preparing labelled diagrams of safety gear and accessories.*

### **4. Fires and fire-fighting equipment**

(a) *Types of fires:*

(i) *Class A;*

(ii) *Class B;*

(iii) *Class C; and,*

(iv) *Class D.*



## **1A: OCCUPATIONAL HEALTH, SAFETY AND THE ENVIRONMENT (cont'd)**

(b) *Fire-fighting equipment:*

- (i) *fire extinguishers (Class A, Class B, Class C and Class D);*
- (ii) *colour codes for fire extinguishers;*
- (iii) *fire hydrants; and,*
- (iv) *fire hoses.*

### **5. Using a fire extinguisher**

- (a) *Safety guidelines and procedures for the various ranges of fires.*
- (b) *Preparing and maintaining report of usage.*
- (c) *Storage and maintenance of fire extinguishers.*

### **6. Accident, injury and emergency**

- (a) *Differences.*
- (b) *Examples (falls, electric shock, minor damages to the eyes, broken bones, cuts).*

### **7. First Aid**

- (a) *First Aid kit station.*
- (b) *Responsibilities of a First Aider.*
- (c) *Treating:*
  - (i) *burns;*
  - (ii) *electric burns;*
  - (iii) *cuts and abrasions;*
  - (iv) *heavy bleeding; and,*
  - (v) *practising mouth-to-mouth resuscitation and recovery position.*

## **1A: OCCUPATIONAL HEALTH, SAFETY AND THE ENVIRONMENT (cont'd)**

### **8. Getting professional help**

- (a) *Procedures for reporting an accident.*
- (b) *Emergency contacts:*
  - (i) *police;*
  - (ii) *fire services;*
  - (iii) *hospital and ambulance service;*
  - (iv) *Red Cross; and,*
  - (v) *the defence force.*
- (c) *Preparing an accident report.*

### **9. Hazards and hazardous substances**

- (a) *Definitions:*
  - (i) *hazard; and,*
  - (ii) *hazardous substance.*
- (b) *Materials Safety Data Sheet.*
- (c) *Storing materials and supplies safely.*

### **10. Mock Drills**

- (a) *Emergency procedures for a fire, an earthquake and a volcano.*
- (b) *Preparing mock drill reports.*

◆ **SECTION 1: FUNDAMENTALS OF TECHNICAL DRAWING**  
**1B: EQUIPMENT, TOOLS, MATERIALS, LETTERING, LINE WORK, DIMENSIONS AND SCALES**

**GENERAL OBJECTIVE**

*On completion of this Section students should understand the importance of Technical Drawing and its success in the appropriate choice and application of equipment, materials and processes in the production of drawings compliant with international standards.*

**SPECIFIC OBJECTIVES**

*Students should be able to:*

1. *discuss the importance of Technical Drawing to industry;*
2. *discuss standards relating to technical drawings;*
3. *outline the functions of equipment and materials used in technical drawing;*
4. *demonstrate the use of tools and equipment;*
5. *classify the various types of lines used in Technical Drawing;*
6. *construct the various types of lines;*
7. *apply basic lettering and dimensioning techniques;*
8. *read and convert measures using various scales;*
9. *apply the principles of freehand sketches;*
10. *apply the principles of CAD;*
11. *explain the steps in the design process;*
12. *outline the principles and elements of design;*
13. *discuss drawing skills in the design process; and,*
14. *design building and engineering components given design specifications.*

## **1B: EQUIPMENT, TOOLS, MATERIALS, LETTERING, LINE WORK, DIMENSIONS AND SCALES (cont'd)**

### **CONTENT**

#### **1. Importance of Technical Drawing as a universal language**

- (a) to the manufacturing industries;
- (b) to engineering;
- (c) to architecture; and,
- (d) to designers.

#### **2. International standards**

- (a) AISI, ISO, BS standards.
- (b) Building codes and standards.
- (c) Engineering codes.

#### **3. Functions of drawing equipment and materials**

- (a) Equipment and tools:
  - (i) drawing boards;
  - (ii) T-squares;
  - (iii) drafting machines;
  - (iv) computers, plotters and printers;
  - (v) cameras;
  - (vi) scanners; and,
  - (vii) multimedia devices.
- (b) Drawing instruments:
  - (i) compasses;
  - (ii) triangles;
  - (iii) protractors;

**1B: EQUIPMENT, TOOLS, MATERIALS, LETTERING, LINE WORK, DIMENSIONS AND SCALES  
(cont'd)**

- (iv) *dividers;*
- (v) *French curves;*
- (vi) *templates;*
- (vii) *lettering guides;*
- (viii) *rulers; and,*
- (ix) *scales.*

**(b) Drawing materials:**

- (i) *drafting paper;*
- (ii) *tracing paper;*
- (iii) *erasers;*
- (iv) *dusting cloth; and,*
- (v) *ink.*

**4. Using tools and equipment**

Techniques and guidelines for different tasks:

- (a) aligning paper to drawing desk;
- (b) constructing title block;
- (c) lettering (styles, upper and lower case);
- (d) lines and line quality;
- (e) dimensioning principles; and,
- (f) producing simple sketches (manual and basic computer operations).



**1B: EQUIPMENT, TOOLS, MATERIALS, LETTERING, LINE WORK, DIMENSIONS AND SCALES  
(cont'd)**

**5. Types of lines**

- (a) The alphabet of lines.
- (b) Line styles *and conventions*.
- (c) *Function/s of each line*.
- (d) *Pencil selection and line quality*.
- (e) *Drawing toolbars*.

**6. Line construction**

*Guidelines and techniques for:*

- (a) *constructing the alphabet of lines using free-hand, instruments (T-squares and triangles) and computer software;*
- (b) *line weight/thickness*.

**7. Lettering and dimensioning techniques**

- (a) *Principles, guidelines and techniques for lettering:*
  - (i) styles;
  - (ii) guidelines;
  - (iii) *uniformity and spacing;*
  - (iv) size;
  - (v) *pencil size and techniques;*
  - (vi) *calligraphy;*
  - (vii) *fonts/texts; and,*
  - (viii) *annotation*.

## **1B: EQUIPMENT, TOOLS, MATERIALS, LETTERING, LINE WORK, DIMENSIONS AND SCALES (cont'd)**

- (b) *Principles, guidelines and techniques for dimensioning:*
  - (i) unidirectional and aligned style of dimensions;
  - (ii) dimension lines, *extension lines, leaders, arrow heads*;
  - (iii) *circles, arcs, radius, diameter*;
  - (iv) *tolerances, limits and fits*;
  - (v) *numbers (standard, metric and decimal); and,*
  - (vi) *dimension toolbar (CAD).*

### **8. Scales**

- (a) *Reading and interpreting:*
  - (i) *draftsmen*;
  - (ii) *engineers*;
  - (iii) *architects; and,*
  - (iv) *standard and metric.*
- (b) *Measuring with scales.*
- (c) *Converting units of measurement.*
- (d) *Applying ratios in engineering and construction drawings according to codes and regulations.*

### **9. Free-hand sketching**

- (a) *Using grid and plane papers.*
- (b) *Pictorial and orthographic drawings.*
- (c) *Sketching in proportion.*
- (d) *Graphic symbols.*
- (e) *Line work.*
- (f) *Sketching of building and engineering components*



**1B: EQUIPMENT, TOOLS, MATERIALS, LETTERING, LINE WORK, DIMENSIONS AND SCALES  
(cont'd)**

**10. Using CAD principles:**

*Refer to page 8 for further details.*

**11. The design process**

- (a) *Identification of the problem.*
- (b) *Design of initial ideas to solve the problem.*
- (c) *Proposed solution.*
- (d) *Development and testing of models/prototypes.*
- (e) *Development of working drawings, notes and sketching to explain each step in the process.*

**12. Principles and Elements of design**

- (a) *Elements of design:*
  - (i) *line;*
  - (ii) *space;*
  - (iii) *form;*
  - (iv) *proportion;*
  - (v) *harmony;*
  - (vi) *dominance; and,*
  - (vii) *finishes.*
- (b) *Principles of design:*
  - (i) *aesthetics;*
  - (ii) *ergonomics;*
  - (iii) *economics;*
  - (iv) *material; and,*
  - (v) *construction.*

**1B: EQUIPMENT, TOOLS, MATERIALS, LETTERING, LINE WORK, DIMENSIONS AND SCALES  
(cont'd)**

**13. *Drawings Skills in the design process***

- (a) *Working drawings.*
- (b) *Principles of Projection.*
- (c) *Manual and computer-aided drafting/design.*

**14. *Designing building and engineering components***

- (a) *Implementing the design process using simple building and engineering components.*
- (b) *Codes and regulations.*
- (c) *Scales.*
- (d) *Materials.*
- (e) *Design presentation and evaluation.*

## ◆ SECTION 2: GEOMETRICAL CONSTRUCTION

### 2A: PLANE GEOMETRY

#### **GENERAL OBJECTIVES**

*On completion of this Section, students should:*

1. *understand the principles of plane geometry and their application in the production of geometric figures and shapes;*
2. *appreciate the principles of plane geometry in the analysis and solution of drawing and design problems in architecture, construction and engineering; and,*
3. *demonstrate proficiency in the use of plane geometry tools, materials and equipment.*

#### **SPECIFIC OBJECTIVES**

*Students should be able to:*

1. *differentiate between “plane geometry” and “solid geometry”;*
2. *apply plane geometrical construction principles using manual and computer-aided methods;*
3. *construct tangents to given specifications;*
4. *apply the basic principles of analytic geometry to Loci;*
5. *illustrate the path of points in simple mechanisms;*
6. *contrast between mathematical and graphical representations of areas of figures;*
7. *construct plane geometric figures equal in areas to other figures;*
8. *divide triangles and polygons into a number of equal and proportional parts; and,*
9. *reduce and enlarge plane figures by linear measurements, ratio of sides and ratio of areas.*

#### **CONTENT**

##### **1. Solid and plane geometry**

*(a) Definitions:*

*(i) solid geometry; and,*

*(ii) plane geometry.*



## SECTION 2A: PLANE GEOMETRY (cont'd)

(c) *Differences:*

- (i) *functions and features of plane and solid geometry; and,*
- (ii) *geometric terms and concepts.*

### 2. Plane Geometry

(a) Lines:

- (i) drawing perpendicular to a given line, at a point on the line and from a point outside the line;
- (ii) drawing a line parallel to a given line;
- (iii) bisecting a given line; *and,*
- (iv) dividing straight lines geometrically (parts of equal lengths and the use of proportion and ratio).

(b) Angles:

- (i) definition;
- (ii) types;
- (iii) properties;
- (iv) copying or transferring any given angle;
- (v) bisecting given angles;
- (vi) bisecting angles formed by two lines;
- (vii) constructing angles (90, 75, 60, 45, 30, 15 degrees and others);
- (viii) replicating geometrical shapes using angle vertices, and converging lines as points of reference;
- (ix) dimensioning and lettering techniques; *and,*
- (x) line characteristics.

(c) Triangles:

- (i) definitions;
- (ii) types;
- (iii) properties; *and,*



## SECTION 2A: PLANE GEOMETRY (cont'd)

- (iv) constructing a triangle (given three sides; two angles and one side; two sides and included angle; perimeter and proportion of sides; altitude and base angles; perimeter and base angles).
- (d) Quadrilaterals:
  - (i) definitions;
  - (ii) types;
  - (iii) properties;
  - (iv) constructing a square (given the length of one side, the perimeter, the diagonal);
  - (v) constructing a rectangle (given the length of the diagonal and one side, perimeter and the length of one side);
  - (vi) constructing a parallelogram (given the lengths of two adjacent sides and an angle, perpendicular height, one side and one internal angle);
  - (vii) constructing a rhombus ( given the length of the sides; one diagonal and the length of one side); *and*,
  - (viii) constructing a trapezium (given the lengths of the sides, perpendicular distance between them and one angle).
- (e) Polygons:
  - (i) definitions (regular and irregular polygons);
  - (ii) types;
  - (iii) properties;
  - (iv) constructing any regular polygon (given the length of a side; diagonal or within a given circle); *and*,
  - (v) constructing any irregular polygon (given the length of the sides, the included angles).

### 3. Tangents

- (a) Definition.
- (b) Properties.



## SECTION 2A: PLANE GEOMETRY (cont'd)

- (c) Tangency of circles, arcs and straight lines.
- (d) Internal and external tangents, centres and tangency points.
- (e) Drawing arcs tangential to two straight lines at acute, right and obtuse angles.
- (f) Constructing the common internal and external tangents to two given circles.
- (g) Drawing an arc tangential to two given circles of different radii.
- (h) Drawing lines, arcs and circles to blend tangentially to create geometric shapes.

### 4. **Analytic geometry**

- (a) Definition, properties and characteristics of ellipse, parabola and hyperbola.
- (b) Constructing an ellipse using the foci (major and minor axis), rectangular and concentric circle methods.
- (c) Constructing a parabola using the locus (distance of the vertex from the directrix) and rectangular methods (span and height).
- (d) Constructing a hyperbola with a given ratio 3:2 (transverse axis and the F focus).
- (e) Constructing an ellipse using trammel method.
- (f) Constructing the tangents and normal to the curves.
- (g) Constructing an Archimedean spiral given the pole and the longest and shortest radii.
- (h) Constructing an involute given the diameter of the circle, triangle, square and regular polygon.

### 5. **Path of points in simple mechanism**

*Collaboration with industry, firms and the industrial technology programmes to access the use of simple mechanisms or representatives of:*

- (a) *sliding ladders;*
- (b) *rotating cranks;*
- (c) *screw threads;*





## SECTION 2A: PLANE GEOMETRY (cont'd)

- (d) cones;
- (e) helical and square springs; and,
- (f) the cycloid.

### 6. **Mathematical and graphical representation of areas of figures**

Differences in shapes and functions of mathematical and graphical representation of:

- (a) rectangles;
- (b) squares;
- (c) triangles;
- (d) circles; and,
- (e) regular and irregular polygons.

### 7. **Geometric figures equal in areas to other figures**

- (a) Constructing a rectangle of equivalent area to:
  - (i) acute and right (angled) triangles; and,
  - (ii) obtuse triangles.
- (b) Constructing a square of equivalent area to:
  - (i) a regular polygon; and,
  - (ii) an irregular polygon.

### 8. **Division of triangles and polygons**

- (a) Construction principles of similar and proportional triangles.
- (b) Dividing triangles and polygons in a number of equal and proportional parts.

## SECTION 2A: PLANE GEOMETRY (cont'd)

### 9. Reducing and enlarging plane figures

- (a) Principles of reducing and enlarging areas of plane figures.
- (b) Reducing and enlarging plane figures by:
  - (i) linear measurements;
  - (ii) ratio of sides; and,
  - (iii) ratio of areas.

## ◆ SECTION 2: GEOMETRICAL CONSTRUCTION

### 2B: SOLID GEOMETRY

#### **GENERAL OBJECTIVES**

*On completion of this Section, students should:*

1. *understand the principles of projecting lines, planes, and views in solid geometry;*
2. *develop proficiency in the use of equipment, tools and materials using the principles and practices in traditional and conventional drawing methods; and,*
3. *apply the principles of sketching, pictorial and orthographic projections.*

#### **SPECIFIC OBJECTIVES**

Students should be able to:

1. *compare the various types of pictorial drawings;*
2. *prepare pictorial drawings;*
3. *discuss the principles of First and Third angle projections;*
4. *prepare orthographic drawings of geometrical solids;*
5. *examine the importance of sectional drawings;*
6. *prepare sectional views of geometrical solids;*
7. *determine the true shapes of sectioned surfaces of geometric solids;*
8. *discuss the different types of auxiliary views;*
9. *prepare auxiliary drawings;*
10. *explain the importance of surface development;*
11. *construct surface development of oblique and frustum solids;*
12. *construct curves of interpenetration of geometric solids with their axes in the same plane;*
13. *draw helical spring of circular cross-section;*
14. *draw orthographic views given pictorial drawings;*
15. *prepare pictorial drawings given orthographic views; and,*
16. *solve drawing problems using orthographic and pictorial projections.*



## SECTION 2B: SOLID GEOMETRY (cont'd)

### CONTENT

#### 1. Pictorial drawings

- (a) Types of pictorial drawings:
  - (i) isometric;
  - (ii) oblique; *and*,
  - (iii) perspective.
- (b) *Characteristics and uses of each type.*
- (c) *Advantages and disadvantages of each type.*
- (d) *Principles of projection for points, lines and planes from one view to the other.*

#### 2. Producing pictorial drawings

- (a) Isometric drawings:
  - (i) *regular shaped objects;*
  - (ii) *irregular shaped objects;*
  - (iii) *objects with inclined surfaces;*
  - (iv) *given the plan and front elevation;*
  - (v) *drawings with isometric circles;*
  - (vi) *drawings with isometric curves; and,*
  - (vii) *exploded isometric drawings.*
- (b) Oblique drawings:
  - (i) *drawing geometric solids in cavalier and cabinet projections; and,*
  - (ii) *drawing figures with curves and circles in cabinet and cavalier oblique projections.*

## SECTION 2B: SOLID GEOMETRY (cont'd)

- (c) Perspective drawings:
  - (i) drawing geometric solids in 1-point perspective; *and*,
  - (ii) drawing geometric solids in 2-point perspective.

### 3. First and third angle projections

Principles relating to the planes of projection:

- (a) horizontal planes;
- (b) vertical planes;
- (c) plans; *and*,
- (d) elevations.

### 4. Orthographic drawings of geometrical solids

- (a) Simple models.
- (b) Truncated solids:
  - (i) rectangular prism and pyramid; *and*,
  - (ii) hexagonal prism.

### 5. Sectional drawings

- (a) *Types.*
- (b) *Characteristics.*
- (c) *Uses.*
- (d) *Preparing sectional drawings:*
  - (i) *full sections;*
  - (ii) *half sections;*
  - (iii) *offset sections;*

## SECTION 2B: SOLID GEOMETRY (cont'd)

- (iv) *revolved sections;*
- (v) *removed sections; and,*
- (vi) *broken out sections.*

### 6. Sectioned surfaces of geometric solids

- (a) Right cones.
- (b) Cylinders.
- (c) Prisms.
- (d) Pyramids.

### 7. Determining true lengths of straight lines

Methods:

- (a) *revolution; and,*
- (b) *auxiliary methods.*

### 8. Auxiliary views

- (a) *Types:*
  - (i) *primary auxiliary views; and,*
  - (ii) *auxiliary views that include curved lines.*
- (b) *Uses and characteristics of the different types.*

### 9. Preparing auxiliary drawings

- (a) Planes of projection for both *inclined and sloping surfaces.*
- (b) Oblique planes inclined to horizontal and vertical planes.

## SECTION 2B: SOLID GEOMETRY (cont'd)

### 10. Surface development

*Uses of surface development for oblique solids and frustum of solids (relevant to the sheet metal industry).*

### 11. Constructing surface developments of oblique and frustum solids

- (a) Applying parallel line and radial development methods for constructing:
  - (i) prisms;
  - (ii) cylinders;
  - (iii) cones;
  - (iv) pyramids;
  - (v) truncated hexagonal pyramid, truncated cylinder;
  - (vi) intersecting cylinders joined at angles; and,
  - (vii) cylinders joined at 90 and 60 degree angles (large and small cylinders).
- (b) Determining true lengths and shapes of the surfaces.

### 12. Curves of interpenetration

- (a) Importance of lines of intersection and their importance in joining solids.
- (b) Constructing curve of interpretation of geometric solids with their axes in the same plane, *horizontal sections, and angles of axes of joined solids.*
- (c) Finding the intersecting lines of two prisms.
- (d) Drawing the curve of interpenetration of two cylinders.

### 13. Helical spring

- (a) Circular cross-section of:
  - (i) helix curves;
  - (ii) pitch;



## SECTION 2B: SOLID GEOMETRY (cont'd)

- (iii) lead; and,
  - (iv) helical and square spring helix.
- (b) Constructing a single helical curve on a cylinder.

### 14. Drawing orthographic views

- (a) Horizontal and vertical planes of projection.
- (b) Plans and Elevations.

### 15. Preparing pictorial drawings

- (a) Isometric.
- (b) Oblique.
- (c) Perspective.

### 16. Solving drawing problems

- (a) Using pictorial drawings:
  - (i) isometric;
  - (ii) oblique; and,
  - (iii) perspective.
- (b) Using First and Third Angle orthographic projections.



## ◆ SECTION 3: BUILDING DRAWING

### **GENERAL OBJECTIVES**

*On completion of the Section, students should:*

1. *understand building standards in the interpretation and preparation of building drawings;*
2. *develop proficiency in the selection and application of appropriate scales for various building drawings;*
3. *develop a working knowledge of the principles of sketching and working drawings;*
4. *appreciate the importance of drafting principles in the analysis and solution of building design problems; and,*
5. *understand the basic principles of entrepreneurship in architectural services and products.*

### **SPECIFIC OBJECTIVES**

Students should be able to:

1. discuss the uses of building standards in the preparation and interpretation of building drawings;
2. discuss the types of drawings used in the building industry;
3. differentiate among various types of architectural drawings;
4. evaluate standard architectural practices;
5. prepare architectural drawings to specifications;
6. compare entrepreneurship and wage employment;
7. discuss the principles of entrepreneurship; *and,*
8. prepare a small business plan for a viable service or product in architecture.

### **CONTENT**

1. **Standards**
  - (a) BSI.
  - (b) ISO.

### **SECTION 3: BUILDING DRAWING (cont'd)**

- (c) CUBiC.
- (d) Local standards.

#### **2. Types of drawings used in the building industry**

- (a) *Types:*
  - (i) *site plans;*
  - (ii) *location plans;*
  - (iii) *building plans; and,*
  - (iv) *elevations and sectional views.*
- (b) *Uses and characteristics of each type of plan.*
- (c) *Labelled sketches of each type of plan.*

#### **3. Types of architectural drawings**

- (a) *Types:*
  - (i) *site plans;*
  - (ii) *general location plans;*
  - (iii) *foundation plans;*
  - (iv) *floor plans;*
  - (v) *building plans; and,*
  - (vi) *elevations and sectional views.*
- (b) *Uses of each type of drawing.*
- (c) *Scales used in preparing the different types of drawings.*
- (d) *Conventional symbols and sketches.*

## SECTION 3: BUILDING DRAWING (cont'd)

### 4. Standard architectural practices

- (a) *Line characteristics.*
- (b) Lettering and dimensioning.
- (c) Symbols.
- (d) Conventions.
- (e) Labelling.
- (f) Notes and annotations.

### 5. Architectural drawings

- (a) Preparing a drawing sheet:
  - (i) Selecting paper size.
  - (ii) Checking alignment.
  - (iii) Drawing border line.
  - (iv) Preparing title block.
  - (v) Line characteristics.
  - (vi) Lettering and dimensioning.
- (b) Producing 2D and 3D solid model drawings of a building or its component using CAD.
- (c) Drawing working plans of building sites:
  - (i) importance of site investigation.
  - (ii) common site clearance practices (demolishing, salvaging, cutting, burning, earth-moving and disposing).
  - (iii) preparing site plans.

### SECTION 3: BUILDING DRAWING (cont'd)

- (iv) factors important to site layout:
  - slope;
  - layout of land;
  - drainage;
  - sewer disposal;
  - fencing;
  - locating boundaries;
  - building regulation for site layout;
  - components of site plan; and,
  - introduction to sub-soils.
  
- (d) *Drawing foundations:*
  - (i) *preparing* simple working drawings of foundation work.
  - (ii) *sketching* concrete foundations of buildings.
  - (iii) *preparing* orthographic, pictorial and freehand sketches of simple reinforcement of foundation work:
    - simple working drawings of foundation work (simple concrete foundations for level and sloping ground); and,
    - preparing drawings of common footings used in building construction (instruments drawings/section details).
  - (iv) drawing foundation plans (position of foundation wall and footing, *line type, line weight, layer, hatching, offset*).
  
- (e) *Drawing floors:*
  - (i) *preparing drawings* of various types of floor and floor section – *timber and concrete*.
  - (ii) *preparing drawings* of solid, hollow and suspended ground floor and floor coverings (tiles, screed, *hardwood, others*).

### SECTION 3: BUILDING DRAWING (cont'd)

- (f) *Drawing* floor plans and elevations:
- (i) *sketching* of floor plans.
  - (ii) *Designing and laying out* simple floor plans from given specifications:
    - orientation and relationship of rooms, positioning of walls, windows, floors, doors, stairs, arches, bathroom and kitchen symbols;
    - line work, dimensioning, annotation;
    - measuring to scale;
    - drawing floor plans to given scales;
    - drawing elevations of buildings;
    - projections and orientation; and,
    - ground line, floor line, doors and windows in elevation, height of roof, fascia, eave, rendering.
- (g) Drawing internal and external walls and finishing:
- (i) *types of walls*:
    - stone rubble;
    - *concrete block*;
    - *brick*; and,
    - *composite walls*.
  - (ii) differentiating between internal and external load bearing and non-load bearing walls (construction of walls in blocks and timber):
    - *drawing* detailed framed timber partition (treatment of openings in walls);
    - *preparing* working drawings of wall details; and,
    - *internal and external rendering (sectional details) of load and non-load bearing walls*, treatment of openings in walls, lintels and ring beams/belt beams, plastering to walls and ceilings.

### SECTION 3: BUILDING DRAWING (cont'd)

- (h) Drawing types of roofs in the Caribbean region:
  - (i) preparing plans and elevations of various types of roofs and roof structures – flat roofs in timber and reinforced concrete and roof construction with various coverings – treatment of gutters, parapets and vent pipes;
  - (ii) preparing working drawings of roof anchorage systems (hurricane clips/straps, bolts);
  - (iii) preparing working drawings of roofs showing truss details (simple contemporary timber trusses); and,
  - (iv) preparing working drawings showing open and closed eaves:
    - eave details;
    - dimensioning and annotations.
- (i) *Drawing doors and windows:*
  - (i) types of doors and windows;
  - (ii) preparing drawings of internal and external doors and windows with linings and frames;
  - (iii) preparing detailed section of a sliding window in a masonry wall (horizontal and vertical sliding windows);
  - (iv) preparing typical sectional drawings which show door and window details and fittings; and,
  - (v) positioning of hinges and locks, plastic hinges and locks.
- (j) *Preparing sectional drawings:*
  - (i) *preparing* full sectional drawings of single-storey buildings;
  - (ii) *using* the principles of orthographic projection for:
    - foundations;
    - floors;
    - walls;
    - roofs; and,

### SECTION 3: BUILDING DRAWING (cont'd)

- *preparing* details of different building components such as ridge, eaves, foundations, floors, footings and anchorage.
- (k) *Drawing* elevations:
  - (i) sketching elevations from given plans;
  - (ii) sketching elevations of building plans;
  - (iii) *drawing* stairs;
  - (iv) principles of construction of stairs (straight flight stairs with landings – timber and reinforced concrete);
  - (v) calculating *risers* from given height;
  - (vi) *preparing* sectional working drawing of a straight flight staircase; and,
  - (vii) *preparing* detailed drawing of the parts of a step.

#### 6. **Comparing entrepreneurship and wage employment**

- (a) *Definitions.*
- (b) *Importance.*
- (c) *Characteristics of wage entrepreneurship.*
- (d) *Characteristics of wage employment.*

#### 7. **Principles of entrepreneurship**

- (a) *Small business planning.*
- (b) *Goal setting.*
- (c) *Value creation.*
- (d) *Product marketing.*
- (e) *Sales and promotion.*

### SECTION 3: BUILDING DRAWING (cont'd)

#### 8. *Preparing a small business plan*

- (a) *Identification of the service or product;*
- (b) *Elements and format of a small business plan; and,*
- (c) *Group presentation and evaluation.*



## ◆ SECTION 4: MECHANICAL ENGINEERING DRAWING

### **GENERAL OBJECTIVES**

*On completion of the Section, students should:*

- 1. develop proficiency in the concepts and conventions for the interpretation and creation of engineering drawings;*
- 2. understand the principles and techniques of sketching, working and assembly drawings in accordance with standards, specifications and instructional guidelines;*
- 3. observe safety and maintenance standards governing the use of drawing tools, equipment and materials according to specifications and instructional guidelines;*
- 4. demonstrate application of the principles and standards of engineering drawings to analyse and solve design problems; and,*
- 5. understand the basic principles of entrepreneurship in Mechanical Engineering Drawing.*

### **SPECIFIC OBJECTIVES**

Students should be able to:

- 1. discuss engineering drawing standards;*
- 2. discuss basic engineering materials;*
- 3. identify conventional representations of standard engineering components;*
- 4. interpret symbols of machine parts and components;*
- 5. identify welding and brazing symbols of fabricated parts and components;*
- 6. prepare engineering drawings;*
- 7. compare entrepreneurship and wage employment;*
- 8. discuss the principles of entrepreneurship; and,*
- 9. prepare a small business plan for a viable service or product.*

## SECTION 4: MECHANICAL ENGINEERING DRAWING (cont'd)

### CONTENT

#### 1. **Engineering drawing standards**

- (a) *International standards relating to:*
  - (i) *line styles and types;*
  - (ii) *lettering;*
  - (iii) *drawing sheets;*
  - (iv) *engineering components and features;*
  - (v) *abbreviations and terms;*
  - (vi) *symbols;*
  - (vii) *surface finishes;*
  - (viii) *tolerance; and,*
  - (ix) *limits and fits.*

#### 2. **Engineering materials**

- (a) *Metals.*
- (b) *Non-metals.*
- (c) *Characteristics of each metal and non-metal material.*
- (d) *Advantages and disadvantages of metal and non-metal material.*

#### 3. **Conventional representation of standard engineering components**

Features, terminologies, symbols and abbreviations of:

- (i) bearings;
- (ii) metric screw thread;
- (iii) shafts;
- (iv) springs;

#### SECTION 4: MECHANICAL ENGINEERING DRAWING (cont'd)

- (v) gears;
- (vi) knurl;
- (vii) flat and round;
- (viii) square;
- (ix) lap;
- (x) countersink;
- (xi) counterbore;
- (xii) spot face;
- (xiii) chamfer;
- (xiv) bevel;
- (xv) tubular sections;
- (xvi) *bush*;
- (xvii) *bearing*;
- (xviii) *housing*;
- (xix) *boss*;
- (xx) *rib*;
- (xxi) *curved slot*;
- (xxii) *fillet*;
- (xxiii) *key*;
- (xxiv) *keyway*;
- (xxv) *bolts*;
- (xxvi) *screws and studs*;
- (xxvii) *pins*;
- (xxviii) *springs*;

## SECTION 4: MECHANICAL ENGINEERING DRAWING (cont'd)

(xxix) *worm and wheel;*

(xxx) *shaft ends; and,*

(xxxi) *splines.*

### 4. Symbols of machine parts

Symbols of components listed in **item 3**.

### 5. Welding and brazing symbols

Fabricated parts and components.

### 6. Engineering drawings

(a) *Sketching* engineering components:

(i) *sketching* engineering features using standard graphic symbols, sectional assemblies;

(ii) *sketching* temporary and permanent fasteners;

(iii) *producing* 3D solid model drawing of engineering components:

- shaped blocks;
- chisels;
- punches;
- nuts and bolts;
- hammers;
- saws;
- vee block;
- clamps;
- mallets;
- anvil;

## SECTION 4: MECHANICAL ENGINEERING DRAWING (cont'd)

- welded joints;
- lathe tail stock;
- lathe centres;
- drill bits;
- taps and dies;
- reamers;
- spanners;
- wrenches;
- tri-square;
- snips;
- stakes;
- hand groover;
- rivet snap; and,
- tap wrench.

(b) *Preparing* title block:

- (i) title of drawing;
- (ii) scale;
- (iii) date of drawing;
- (iv) name of draftsman;
- (v) drawing number;
- (vi) revisions;
- (vii) symbol of projection;
- (viii) lettering;
- (ix) size of drawing sheets; and,
- (x) use of guidelines.

## SECTION 4: MECHANICAL ENGINEERING DRAWING (cont'd)

- (c) Preparing orthographic drawings:
- (i) simple machine parts and components in first angle or third angle projection:
    - vee blocks;
    - plumber block;
    - tool holders;
    - tool post;
    - connecting rod;
    - pulley frame;
    - pulleys;
    - pulley yoke;
    - lever bracket;
    - machine vice body;
    - shaft bearing; and,
    - angle plate base, pivot block, bearing block and axle support.
  - (ii) *simple machine parts and components in scaled orthographic views (first angle or third angle projection).*
  - (iii) orthographic drawings of temporary and permanent engineering fasteners:
    - temporary fasteners - nuts and bolts, screws, studs, cotters, locknuts, slotted nuts, castle nuts, self-locking nuts, spring washers, saddle keys, round keys, feather keys, parallel keys, taper keys, woodruff keys, split pins; and,
    - permanent fasteners – rivets, conventional representation of welds and brazing: fillet, vee, butt, spot. Indication of direction, site and location of weld.
- (d) Dimensioning drawings:
- (i) stop (extension) lines;
  - (ii) dimension lines;



## SECTION 4: MECHANICAL ENGINEERING DRAWING (cont'd)

- (iii) arrowheads;
  - (iv) leaders;
  - (v) overall dimensions;
  - (vi) chain dimensioning;
  - (vii) linear dimensioning;
  - (viii) dual dimensioning;
  - (ix) angular dimensioning;
  - (x) tolerance dimensions; and,
  - (xi) radius, diameter, circles, arcs and metric screw threads.
- (e) Sections
- (i) types of sections:
    - full;
    - half;
    - part;
    - off-set;
    - revolved;
    - removed; and,
    - local.
  - (ii) sectional plans and elevations of:
    - vee block;
    - plumber block;
    - connecting rod;
    - pulleys;
    - lever bracket;

## SECTION 4: MECHANICAL ENGINEERING DRAWING (cont'd)

- machine vice body;
- shaft bearing;
- angle base plate;
- support block;
- support arm;
- support plate;
- brackets;
- jig body;
- shaper quadrant;
- tension block;
- bearing block;
- lathe tool post;
- link connector;
- compound rest; and,
- crank.

(f) *Preparing assembly drawings:*

(i) plans and elevations in first angle or third-angle projection of assembled machine parts and components:

- shaft and pulleys;
- castors;
- jigs and fixtures;
- machine and bench vices;
- bearing assemblies;
- universal couplings;



## SECTION 4: MECHANICAL ENGINEERING DRAWING (cont'd)

- lathe steady;
  - pulley and hook;
  - shaft block and bearing;
  - tool supports and holders;
  - lathe tail stock;
  - valve link connector;
  - connecting rod and bearing;
  - screw jack;
  - scribing block;
  - clamping devices;
  - vee block and clamp;
  - crank and pin;
  - footstep bearing;
  - clapper box;
  - eccentrics;
  - tool rest;
  - pipe vice; and,
  - swivel.
- (ii) drawing sectional plans and elevations of assembled machine parts;
- (iii) reading and preparing working drawings of machine parts and components;
- (iv) preparing parts list of machine components; and,
- (v) parts list given machine components showing parts number, name of parts; number required, material, remarks; balloon referencing.

## **SECTION 4: MECHANICAL ENGINEERING DRAWING (cont'd)**

### **7. *Entrepreneurship and wage employment***

- (a) *Definitions.*
- (b) *Importance.*
- (c) *Characteristics of wage entrepreneurship.*
- (d) *Characteristics of wage employment.*

### **8. *Principles of entrepreneurship***

- (a) *Small business planning.*
- (b) *Goal setting.*
- (c) *Value creation.*
- (d) *Product marketing.*
- (e) *Sales and promotion.*

### **9. *Preparing a small business plan***

- (a) *Identification of the service or product.*
- (b) *Elements and format of a small business plan.*
- (c) *Group presentation and evaluation.*

## ◆ SUGGESTED TEACHING AND LEARNING ACTIVITIES

*To facilitate students' performance, teachers/facilitators are advised to engage students in the teaching and learning activities listed below.*

- 1. Use PowerPoint presentations, simulations, videos, interactive boards, Internet, and CDs to support the teaching and expose students to industry standards, trends and practices. Students should be encouraged to journal lessons learnt from presentations.*
- 2. Organise work attachments (job placement, work experience, job shadowing or apprenticeship) with agencies of Government, drafting/architectural firms, fabrication/construction companies to give students an opportunity to observe the application of the various standards and compare the practices observed with the documented standards and expectations. Students can present their findings in class.*
- 3. Utilise subject specialists and practitioners from agencies of Government, drafting/architectural firms, fabrication/construction companies to make presentations and perform demonstrations for students.*
- 4. Arrange site visits to agencies of Government, drafting/architectural firms, fabrication/construction companies and suppliers of drawing equipment, tools and materials for students to observe standardised processes and interact with new drawing resources. Students can develop an instructional manual complete with safety precautions for the tools and equipment to which they were exposed on the visit.*
- 5. Monitor the completion and maintenance of the portfolio and ensure the pieces of evidence of the competencies that each student develops are included and validated against established standards and requirements and give students structured feedback.*

## ◆ GUIDELINES FOR THE SCHOOL-BASED ASSESSMENT

School-Based Assessment (SBA) is an integral part of candidates' assessment in the course covered by this programme. It is intended to facilitate the development of all the critical competencies (knowledge, skills, attitudes) emphasised by this programme. The SBA seeks to individualise a part of the programme to meet the needs of candidates, facilitate feedback to the candidates at various stages of the experience and help to build the self-confidence of candidates as they proceed with their studies. It enhances the validity of the examination on which candidate performance is reported, thereby, making a significant and unique contribution to the development of relevant academic and work-related skills.

*The SBA is a composite of the marks derived from the portfolio pieces which show a clear integration of the recommended Units of Competence for the integration of the CVQ. The selected standards and Units of Competence for integration are:*

1. *General Construction (CCBCG10102), Draw and interpret simple drawings (BCGCOR0031A);*
2. *Furniture Making (CCLMF10103), Read and interpret work documents (LMFCOR0071A);*
3. *Electrical Installation (CCMEM11002), Draw and interpret sketches and simple drawings (MEMCOR0091A); or*
4. *Metal Work Engineering (CCMEM10302), Draw and interpret sketches and simple drawings (MEMCOR0091A).*

*Two exemplars have been included in this syllabus. Teachers are encouraged to use these to guide the development of projects/practical activities for the School-Based Assessment component of this syllabus. Assessment is evidence-based. Candidates are therefore required to prepare and submit a portfolio of their work. **Please refer to Appendix III for Portfolio Development Guidelines.***

*The CVQ is an award which represents the achievement of a set of competencies that define the essential (core) work practices of an occupational area consistent with the levels articulated within the Regional Qualifications Framework. It aims at the development of the Ideal Caribbean Worker, seeks to facilitate the movement of skilled certified workers within the CSME, and to enhance the quality profile and investment attractiveness of the work/labour force of CARICOM states while harmonising TVET systems across the region. The inclusion of the CVQ in secondary schools is a collaboration among the Ministry of Education, National Training Agencies/TVET Councils, Institutions and CXC.*

The guidelines provided in this document for selecting appropriate tasks are intended to assist teachers/facilitators and candidates in formulating assignments that are valid for the purpose of SBA. The guidelines provided for the assessment of the assignments are intended to assist teachers/facilitators in awarding marks that are reliable indicators of the achievement of candidates in the SBA component of the programme.

## **SUGGESTED ACTIVITIES FOR THE SBA**

The SBA assessment will contain:

1. One piece from Section 1 (Specific Objectives 1 to 10) and Section 2 (Specific Objectives 1 and 2). This is a written question.
2. Two pieces from Section 2 (Plane Geometry and Solid Geometry).
3. The projects from Section 3 or Section 4.

*The following provides some suggested activities which could be used to enhance the learning experience provided by the SBA. This is by no means an exhaustive list as teachers/facilitators are encouraged to explore other creative activities intended to transform the learning environment.*

- (a) *Oral questioning.*
- (b) *Oral presentation of design justification.*
- (c) *Presentation of design justification to teacher/facilitator or visiting Architect/Engineer in a formal atmosphere.*
- (d) *Internet exploration – evidence.*
- (e) *Freehand sketching.*
- (f) *Use of on-site situations when candidates could easily take measurements, soil tests.*
- (g) *Use of real machine parts.*
- (h) *Guest speakers from industry.*
- (i) *Peer assessment of designs.*
- (j) *Group assignments and marking.*
- (k) *Site visits.*

## **PROCEDURES FOR THE SCHOOL-BASED ASSESSMENT PORTFOLIO**

*As part of the School-Based Assessment, candidates will be required to produce a formative developmental portfolio providing evidence of candidates' progress and learning over the duration of the programme. This evidence may be in the form of sketches, design plans, quality control procedures, multi-view drawings, self-reflective statements, transcripts of interviews with industry professionals.*

*Since the portfolio is an accumulation of the candidates' ongoing learning across the course of the two-year programme, it must be started at the commencement of the Technical Drawing programme.*



The pieces of evidence MUST depict the candidates' developmental progress in each section of the syllabus. It is advised that the topics of the content be integrated to give full coverage of each section of the syllabus. This integrated approach may result in the creation of evidence that covers more than one topic in the syllabus.

At a minimum, the portfolio must contain the following from each Section.

1. Section 1 (Fundamental of Technical Drawing):
  - (a) Evidence on Occupational Health Safety and the Environment;
  - (b) Checklist of evidence of site visit (for example, name of company, contact person, summary of organisation's health and safety practices, safety practice deficiencies identified, environmental practices, photographs or other forms of evidence);
  - (c) Project evidence on various types of lines, symbols, drawing conventions and codes;
  - (d) Project evidence on drawing equipment and instruments.
2. Section 2 (Geometrical Construction):
  - (a) Pieces of evidence on Plane Geometry and Solid Geometry;
  - (b) The evidence MUST be derived from different topics within the Section.
3. Section 3 or 4 (Building Drawing or Mechanical Engineering Drawing):
  - (a) Evidence of these sections will take the following format;
  - (b) Design/redesign a Building component or Mechanical Engineering device/gadget to solve a simple functional problem in one of the fourteen categories, namely:  
Categories
    - (i) agriculture/Fishing;
    - (ii) business/office;
    - (iii) communication;
    - (iv) construction;
    - (v) household;
    - (vi) education facilities;
    - (vii) environment;
    - (viii) health facilities;
    - (ix) manufacturing;

- (x) power;
- (xi) recreation;
- (xii) recycling;
- (xiii) sports; and,
- (xiv) transportation.

For **Building Drawing**, candidates will be required to produce the following:

- (a) sketch;
- (b) floor plan;
- (c) at least two elevations;
- (d) sectional view;
- (e) foundation plan or roof plan or sectional details of foundation and eaves; and,
- (f) a small business plan to encompass design justification and conditions.

For **Mechanical Engineering Drawing**, candidates will be required to produce the following drawings:

- (a) parts sheet;
- (b) orthographic projection of plan of the assembly;
- (c) sectional view of the assembly;
- (d) pictorial sketch;
- (e) parts list; and,
- (f) a small business plan to encompass design justification and conditions.

**SCHOOL- BASED ASSESSMENT**  
**ASSESSMENT PLAN**  
**EXEMPLAR 1 – Mechanical Drawing**

This School-Based Assessment is aligned to Draw and Interpret Sketches and Simple Drawings (MEMCOR0091A) in the Metal Work Engineering, Level I (CCMEM10302) Regional Occupational Standard.

**CANDIDATE:** \_\_\_\_\_ **ASSESSOR:** \_\_\_\_\_

**Elements:**

- Prepare freehand sketch.
- Interpret details from freehand sketch.
- Select correct technical drawing.
- Identify drawing requirements.
- Prepare or make changes to engineering drawing.

ALL UNDIMENSIONED RADII  $\frac{1}{4}$ "

**BEARING ASSEMBLY**

PART No.	No OFF	DESCRIPTION	MTL.
1	1	BRACKET	M. S.
2	1	BRACKET	C. I.
3	2	BUSH	R. BRONZ.

Work Activities	Assessment Methods
<p>Your client has presented you with a working drawing to provide a completed assembled drawing with a detailed parts list. Your drawing with print title, symbol of projection, scale and full dimension must show a suitable pin position and be complete with the following views:</p> <ul style="list-style-type: none"> <li>- a sectional front elevation;</li> <li>- an end elevation; and</li> <li>- a plan.</li> </ul>	<ul style="list-style-type: none"> <li>• Practical demonstration.</li> <li>• Oral questions.</li> <li>• Drawing evaluation.</li> </ul>



<b>Underpinning Knowledge and Skills</b>	<b>Range</b>
<ul style="list-style-type: none"> <li>• <i>Measurements. Ability to estimate and measure accurately.</i></li> <li>• <i>Simple Drawings. Ability to read and interpret them.</i></li> <li>• <i>Drawing Tools. Ability to recognise them and use them accurately.</i></li> <li>• <i>Lines. Ability to differentiate between alphabet of lines, line type variation, order of usage and application on drawings.</i></li> <li>• <i>Scale and proportion. Apply types of scale and proportion to measurements on drawings.</i></li> <li>• <i>Symbols, dimensions and terminology. Apply to types of drawings.</i></li> </ul>	<ul style="list-style-type: none"> <li>• <i>Technical drawings may utilise perspective, exploded views or hidden view.</i></li> <li>• <i>Multi-view full scale (orthographic 2-D) drawings that show all hidden features and centerlines.</i></li> <li>• <i>Measurement systems (inch/foot system and metric [SI] system).</i></li> <li>• <i>Alphabet of line (object line, hidden line, centre line, section line, dimension, extension line, cutting line, short break line, phantom line).</i></li> <li>• <i>Geometric construction to include (circles, regular polygons with four, seven and eight sides, pentagon inscribed within measured circle, ellipse, triangles with specified angles, arcs through three points tangent to two and circles).</i></li> </ul>
<p><b>Candidate's Signature:</b> _____ <b>Date:</b> _____</p> <p><b>Assessor's Signature:</b> _____ <b>Date:</b> _____</p> <p><b>Internal Verifier's Signature:</b> _____ <b>Date:</b> _____</p>	

**EXEMPLAR 1 – Mechanical Drawing**  
**DIMENSIONS OF COMPETENCY**

*This School-Based Assessment is aligned to Draw and Interpret Sketches and Simple Drawings (MEMCOR0091A) in the Metal Work Engineering, Level I (CCMEM10302) Regional Occupational Standard.*

<b>WORK ACTIVITY:</b>	
<p><i>Your client has presented you with a working-drawing to provide a completed assembled drawing with a detailed parts list. Your drawing with print title, symbol of projection, scale and full dimension must show a suitable pin position and be complete with the following views:</i></p> <ul style="list-style-type: none"> <li>- <i>a sectional front elevation;</i></li> <li>- <i>an end elevation; and</i></li> <li>- <i>a plan.</i></li> </ul>	
<b>TASK SKILLS</b>	<b>TASK MANAGEMENT SKILLS</b>
<p><i>Candidate has to...</i></p> <ul style="list-style-type: none"> <li>• <i>Interpret activity</i></li> <li>• <i>Follow health and safety requirements</i></li> <li>• <i>Select and accurately use the necessary tools, equipment</i></li> <li>• <i>Measure accurately within the prescribed scale</i></li> <li>• <i>Demonstrate appropriate use of lines</i></li> <li>• <i>Use appropriate drawing techniques</i></li> <li>• <i>Prepare and present accurate parts list</i></li> <li>• <i>Prepare and present accurately assembled drawings</i></li> </ul>	<p><i>Prepare/organise/ co-ordinate by...</i></p> <ul style="list-style-type: none"> <li>• <i>Interpret and plan activity</i></li> <li>• <i>Select tools, equipment and materials</i></li> <li>• <i>Apply health and safety procedures</i></li> <li>• <i>Organise work station</i></li> <li>• <i>Work in a logical and sequential manner within the required time frame</i></li> <li>• <i>Prepare and present drawings in keeping with clients expectations</i></li> </ul>
<b>CONTINGENCY MANAGEMENT SKILLS</b>	<b>EMPLOYABILITY/ JOB ROLE/ ENVIRONMENT SKILLS</b>
<p><i>What if ...?</i></p> <ul style="list-style-type: none"> <li>• <i>The required software is unavailable</i></li> <li>• <i>The tools and equipment needed are malfunctioning or in adequate</i></li> </ul>	<p><i>The candidate can ...</i></p> <ul style="list-style-type: none"> <li>• <i>Collect, analyse and organise information</i></li> <li>• <i>Communicate ideas and information</i></li> <li>• <i>Plan and organise activities</i></li> <li>• <i>Work with others and in team</i></li> <li>• <i>Use mathematical ideas and techniques</i></li> <li>• <i>Solve problems</i></li> <li>• <i>Use technology</i></li> </ul>

**Assessor's Signature:** \_\_\_\_\_

**Date:** \_\_\_\_\_



KEY  
 Competent - Range 3 and above  
 Not Yet Competent - below Range 3

**EXEMPLAR 1 – Mechanical Drawing  
 ASSESSOR EVALUATION**

*This School-Based Assessment is aligned to Draw and Interpret Sketches and Simple Drawings (MEMCOR0091A) in the Metal Work Engineering, Level I (CCMEM10302) Regional Occupational Standard.*

**Institution/ Centre:** \_\_\_\_\_

**Candidate's Name:** \_\_\_\_\_

ASSESSMENT CRITERIA	ASSESSOR				
	1	2	3	4	5
<b>1. DRAWING</b>					
<i>Sketch is to depict object or part correctly and appropriately drawn</i>					
<i>Correctly and appropriately drawn</i>					
<i>Depicts object or part accurately</i>					
<i>Dimensions are obtained correctly</i>					
<i>Dimensions are shown clearly</i>					
<i>Instructions are shown clearly</i>					
<i>Base line or datum point is indicated</i>					
<i>Components, assemblies or objects are recognised</i>					
<i>Dimensions identified are appropriate</i>					
<i>Instructions are identified and followed</i>					
<i>Material requirements are identified</i>					
<i>Symbols are recognised in sketch</i>					
<i>Drawing is checked and validated against job requirements or equipment</i>					
<i>Drawing version is checked and validated</i>					
<i>Requirements and purpose of drawing is determined from customer and/or work specification and associated documents</i>					
<i>Identified and collected all data necessary to produce the drawing</i>					
<i>Drawing requirements are confirmed with relevant personnel and timeframes for completion established</i>					
<i>Selected appropriate drafting equipment for engineering drawing</i>					
<i>Drafting principles applied to produce a drawing that is consistent with industry standards</i>					
<i>All work is undertaken to prescribed procedure</i>					
<i>Completed drawing is in accordance with standard operating procedures</i>					
<i>Lettering done to standard</i>					
<i>Title block represent required information</i>					
<b>2. DETAILED PARTS LIST</b>					
<i>List includes all required sections</i>					
<i>Items are accurately named/identified with correct spelling</i>					
<i>Dimension of the items included are accurate</i>					
<i>All required items accounted for on list</i>					
<i>Items on list accurately quantified</i>					
<i>Symbols appropriately used where necessary</i>					



**Comment/ Feedback:**

---

---

**Rating Scale:**

1. Cannot perform this task.
2. Can perform this task with **constant** supervision and **considerable** assistance.
3. Can perform this task with **constant** supervision and **some** assistance.
4. Can perform this task satisfactorily with periodic supervision.
5. Can perform this task satisfactorily with little or no supervision.

**Assessor's Signature:** \_\_\_\_\_ **Date:** \_\_\_\_\_

**Candidate's Signature:** \_\_\_\_\_ **Date:** \_\_\_\_\_

**SCHOOL-BASED ASSESSMENT  
ASSESSMENT PLAN  
EXEMPLAR 2 – Building Drawing**

This School-Based Assessment is aligned to Draw and interpret simple drawings (BCGCOR0031A) in the General Construction, Level I (CCBCG10102) Regional Occupational Standard.

**CANDIDATE:** \_\_\_\_\_ **ASSESSOR:** \_\_\_\_\_

**Elements:**

- |  |  |
|--|--|
| <ul style="list-style-type: none"> <li>• Prepare for drawing</li> <li>• Draw geometric constructions</li> <li>• Construct multi-view (orthographic 2-D) drawing</li> <li>• Develop a pictorial (3D) drawing</li> </ul> | <ul style="list-style-type: none"> <li>• Construct and dimension Drawings</li> <li>• Apply notes and leaders</li> <li>• Prepare freehand sketch</li> <li>• Interpret details from sketches and drawings</li> </ul> |
|--|--|

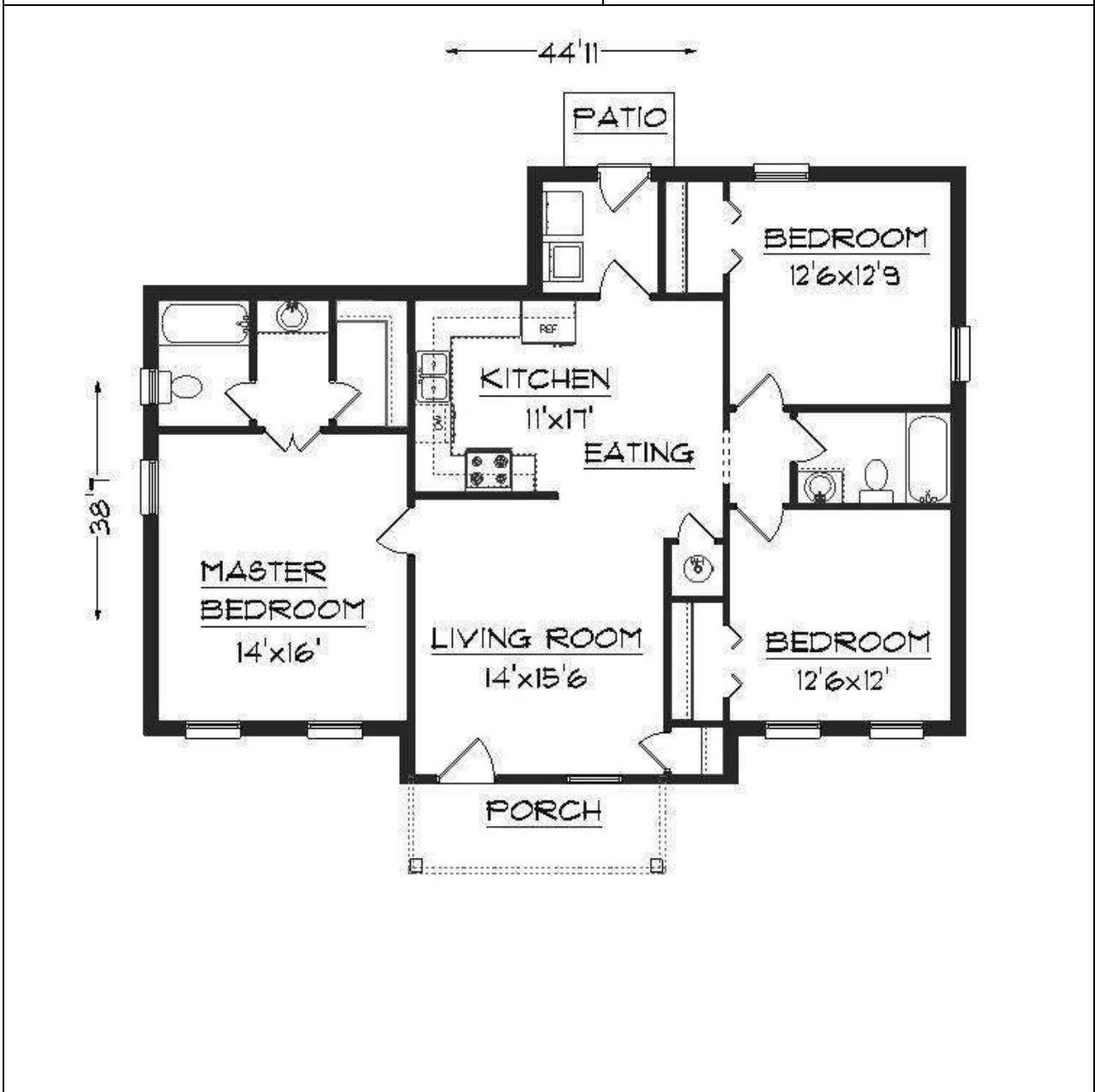

Work Activities	Assessment Methods
<p>Your client has presented you with a floor plan of a three-bedroom house to be completed. Your drawing, with print title, scale and full dimensions must be completed with the following:</p> <ul style="list-style-type: none"> <li>• front elevation taken from the direction of the porch;</li> <li>• side elevation from the left of the porch; and</li> <li>• roof plan to show the design of the roof and roof members.</li> </ul>	<ul style="list-style-type: none"> <li>• Practical demonstration.</li> <li>• Oral questions.</li> <li>• Drawing evaluation.</li> </ul>
Underpinning Knowledge and Skills	Range
<ul style="list-style-type: none"> <li>• <b>Measurements.</b> Ability to estimate and measure accurately.</li> <li>• <b>Simple Drawings.</b> Ability to read and interpret them.</li> <li>• <b>Drawing Tools.</b> Ability to recognise them and use them accurately.</li> <li>• <b>Lines.</b> Ability to differentiate between alphabet of lines, line type variation, order of usage and application on drawings.</li> <li>• <b>Scale and proportion.</b> Apply types of scale and proportion to measurements on drawings.</li> <li>• <b>Symbols, dimensions and terminology.</b> Apply to types of drawings.</li> <li>• <b>Prepare technical drawings with drawing instruments and with Auto CAD.</b></li> </ul>	<ul style="list-style-type: none"> <li>• <b>Technical drawings may utilise perspective, exploded views or hidden view.</b></li> <li>• <b>Multi-view full scale (orthographic 2-D) drawings that show all hidden features and centerlines.</b></li> <li>• <b>Measurement systems (inch/foot system and metric [SI] system).</b></li> <li>• <b>Alphabet of line (object line, hidden line, centre line, section line, dimension, extension line, cutting line, short break line, phantom line).</b></li> <li>• <b>Scales.</b> Architectural, metric, engineering and civil.</li> <li>• <b>Geometric construction to include (circles, regular polygons with four, seven and eight sides, pentagon inscribed within measured circle, ellipse, triangles with specified angles, arcs through three points tangent to two and circles).</b></li> <li>• <b>Drawing Dimensions (2D).</b> Dimensioning complex shapes: spheres, cylinders, tapers, and pyramids.</li> <li>• <b>Drawing Dimensions (3D).</b> Full scale (1:1) basic isometric drawing. Isometric corner with left and right side lines each 30 degrees up from horizontal and third line at a vertical, with all three lines joining in a common intersection.</li> </ul>
<p><b>Candidate's Signature:</b> _____ <b>Date:</b> _____</p> <p><b>Assessor's Signature:</b> _____ <b>Date:</b> _____</p> <p><b>Internal Verifier's Signature:</b> _____ <b>Date:</b> _____</p>	

**EXEMPLAR 2 – Building Drawing**  
**DIMENSIONS OF COMPETENCY**

This School-Based Assessment is aligned to Draw and interpret simple drawings (BCGCOR0031A) in the General Construction, Level I (CCBCG10102) Regional Occupational Standard.

<b>WORK ACTIVITY:</b>	
<p>Your client has presented you with a floor plan to provide completed elevations and a roof plan. Your drawing with print title, scale and full dimension must show the following:</p> <ul style="list-style-type: none"> <li>- a front elevation taken from the direction of the porch;</li> <li>- a side elevation taken from the left of the porch; and</li> <li>- a roof plan to show the design of the roof and roof members.</li> </ul>	
<b>TASK SKILLS</b>	<b>TASK MANAGEMENT SKILLS</b>
<p>Candidate has to...</p> <ul style="list-style-type: none"> <li>• Interpret activity</li> <li>• Follow health and safety requirements</li> <li>• Select and accurately use the necessary tools, equipment</li> <li>• Identify and understand various types of drawings</li> <li>• Identify alphabet of lines, scales, lettering, dimensions, symbols, abbreviations and key features</li> <li>• Identify title panel and reference date of drawings</li> <li>• Measure accurately within the prescribed scale</li> <li>• Demonstrate appropriate use of lines</li> <li>• Use appropriate drawing techniques</li> <li>• Prepare and present accurate elevations</li> <li>• Prepare and present accurate roofing plan</li> </ul>	<p>Prepare/organise/co-ordinate by...</p> <ul style="list-style-type: none"> <li>• Interpret and plan activity</li> <li>• Select tools, equipment and materials</li> <li>• Apply health and safety procedures</li> <li>• Organise work station</li> <li>• Work in a logical and sequential manner within the required time frame</li> <li>• Present and present drawings in keeping with clients expectations</li> </ul>
<b>CONTINGENCY MANAGEMENT SKILLS</b>	<b>EMPLOYABILITY/ JOB ROLE/ ENVIRONMENT SKILLS</b>
<p>What if ...?</p> <ul style="list-style-type: none"> <li>• The required software is unavailable</li> <li>• The tools and equipment needed are malfunctioning or in adequate</li> </ul>	<p>The candidate can ...</p> <ul style="list-style-type: none"> <li>• Collect, analyse and organise information Level 1</li> <li>• Communicate ideas and information Level 1</li> <li>• Plan and organise activities Level 1</li> <li>• Work with others and in team Level 1</li> <li>• Use mathematical ideas and techniques Level 1</li> <li>• Solve problems Level 1</li> <li>• Use technology</li> </ul>

**Assessor's Signature:** \_\_\_\_\_

**Date:** \_\_\_\_\_



<p>KEY          Competent - Range 3 and above          Not Yet Competent - below Range 3</p>
--

**EXEMPLAR 2 – Building Drawing**

**ASSESSOR EVALUATION**

This School-Based Assessment is aligned to Draw and interpret simple drawings (BCGCOR0031A) in the General Construction, Level I (CCBCG10102) Regional Occupational Standard.

**Institution/ Centre** : \_\_\_\_\_

**Candidate's Name** : \_\_\_\_\_

ASSESSMENT CRITERIA	ASSESSOR				
	1	2	3	4	5
<b>1. DRAWING</b>					
<i>Sketch appropriately drawn with applicable views</i>					
<i>Correctly and appropriately drawn</i>					
<i>Depicts object or part accurately</i>					
<i>Dimensions are obtained correctly</i>					
<i>Dimensions are shown clearly</i>					
<i>Instructions are shown clearly</i>					
<i>Base line or datum point is indicated</i>					
<i>Components or objects are recognised</i>					
<i>Dimensions identified are appropriate</i>					
<i>Instructions are identified and followed</i>					
<i>Material requirements are identified</i>					
<i>Symbols are recognised in sketch</i>					
<i>Drawing is checked and validated against job requirements or equipment</i>					
<i>Drawing version is checked and validated</i>					
<i>Requirements and purpose of drawing are determined from customer and/or work specification and associated documents</i>					
<i>Identified and collected all data necessary to produce the drawing</i>					
<i>Drawing requirements are confirmed with relevant personnel and timeframes for completion established</i>					
<i>Selected appropriate drafting equipment for building drawing</i>					
<i>Drafting principles applied to produce a drawing that is consistent with industry standards</i>					
<i>All work is undertaken to prescribed procedure</i>					
<i>Completed drawing is in accordance with standard operating procedures</i>					
<i>Lettering done to standard</i>					
<i>Title block represent required information</i>					
<i>Completed drawing illustrates correct application of notes and leaders.</i>					
<b>2. ROOFING PLAN</b>					
<i>Roof design is appropriate for the layout of the building</i>					
<i>Roof members are accurately named/identified with correct spelling</i>					
<i>Dimension of roof members is included and are accurate</i>					
<i>All required roof members are accounted for on the plan</i>					
<i>Symbols appropriately used where necessary</i>					





**Comment/ Feedback:**

---

---

**Rating Scale:**

1. Cannot perform this task.
2. Can perform this task with **constant** supervision and **considerable** assistance.
3. Can perform this task with **constant** supervision and **some** assistance.
4. Can perform this task satisfactorily with periodic supervision.
5. Can perform this task satisfactorily with little or no supervision.

**Assessor's Signature** : \_\_\_\_\_

**Date:** \_\_\_\_\_

**Candidate's Signature** : \_\_\_\_\_

**Date:** \_\_\_\_\_

## ◆ RESOURCES

- Duncan, M.L. *Second Steps in Technical Drawing*. Trinidad: DCT Publishers, 1998.
- Goetsh, D.E., Nelson, J., and Chalk, W.S. *Chalk Technical Drawing*, 4<sup>th</sup> Edition. New York: Delmar Publishers, 2000.
- Maguire, D. and Simmons C. *A Manual of Engineering Drawing*. London: Edward Arnold, 1995.
- Morling, K. *Geometric and Engineering Drawing*, 2<sup>nd</sup> Edition. London: Edward Arnold, 1974.
- Ezeji, S.C. and Nwoke, G.I. *Technical Drawing 3: Building Drawing*. Longman International, 1992.
- Yarwood, A. *Technical Drawing With Design: The Motivate Series*. London: The Macmillan Press Ltd, 1994.

### WEBSITES

<http://www.technologystudent.com/>  
[www.smartdraw.com](http://www.smartdraw.com)  
[www.autodesk.com](http://www.autodesk.com)

## ◆ GLOSSARY OF TERMS

<u>WORD/TERM</u>	<u>DEFINITION/MEANING</u>
account for	Present reason for action or event
annotate	add a brief note to a label
apply	use knowledge of principles to solve problems
assess	present reasons for the importance of particular structures, relationships or process
calculate	arrive at the solution to a numerical problem
classify	divide into groups according to observable characteristics
comment	state opinion or view with supporting reasons
compare	state similarities and differences
construct	use a specific format to make and draw a graph, histogram, pie chart or other representation using data or material provided or drawn from practical investigations, build (for example, a model), draw scale diagram
deduce	make a logical connection between two or more pieces of information; use data to arrive at a conclusion
define	state concisely the meaning of a word or term
demonstrate	show; direct attention to...
describe	provide detailed factual information of the appearance or arrangement of a specific structure or a sequence of a specific process
determine	find the value of a physical quantity
design	plan and present with appropriate practical detail
develop	expand or elaborate an idea or argument with supporting reasons
diagram	simplified representation showing the relationship between components.
differentiate	state or explain briefly those differences between or among items which can be used to define the items or place them into separate categories.
discuss	present reasoned argument; consider points both for and against; explain the relative merits of a case
draw	make a line representation from specimens or apparatus which shows an accurate relation between the parts
estimate	make an approximate quantitative judgement



<b><u>WORD/TERM</u></b>	<b><u>DEFINITION/MEANING</u></b>
evaluate	weigh evidence and make judgements based on given criteria
explain	give reasons based on recall; account for
find	locate a feature or obtain as from a graph
formulate	devise a hypothesis
identify	name or point out specific components or features
illustrate	show clearly by using appropriate examples or diagrams, sketches
investigate	use simple systematic procedures to observe, record data and draw logical conclusions
label	add names to identify structures or parts indicated by pointers
list	itemise without detail
measure	take accurate quantitative readings using appropriate instruments
name	give only the name of
note	write down observations
observe	pay attention to details which characterise a specimen, reaction or change taking place; to examine and note scientifically
outline	Give basic steps only
plan	prepare to conduct an investigation
predict	use information provided to arrive at a likely conclusion or suggest a possible outcome
record	write an accurate description of the full range of observations made during a given procedure
relate	show connections between; explain how one set of facts or data depend on others or are determined by them
sketch	make a simple freehand diagram showing relevant proportions and any important details
state	provide factual information in concise terms outlining explanations
suggest	offer an explanation deduced from information provided or previous knowledge. (... a hypothesis; provide a generalisation which offers a likely explanation for a set of data or observations.)
test	to find out, following set procedures



**CARIBBEAN EXAMINATIONS COUNCIL  
SCHOOL-BASED ASSESSMENT  
MARK SCHEME**

**SUBJECT: TECHNICAL DRAWING**

**PROFICIENCY: TECHNICAL**

**YEAR:** ..... **CENTRE #:** .....

**CANDIDATE #:** ..... **TERRITORY:** .....

**NAME OF TEACHER:** .....

**PRESENTATION /ORGANISATION OF PORTFOLIO**

**SECTION 1: FUNDAMENTALS OF TECHNICAL DRAWING**

KNOWLEDGE	MARKS		APPLICATION	MARKS		PRACTICAL ABILITY	MARKS	
		Max			Max			Max
Knowledge of: <ul style="list-style-type: none"> <li>• Theory of Specific objectives 1.1 – 1.10;</li> <li>• 2.1 and 2.2.</li> </ul>		4	Application of: <ul style="list-style-type: none"> <li>• Theory of Specific objectives 1.1 – 1.10;</li> <li>• 2.1 and 2.2.</li> </ul>		6			
		<b>4</b>			<b>6</b>			<b>0</b>

**CARIBBEAN EXAMINATIONS COUNCIL  
SCHOOL-BASED ASSESSMENT  
MARK SCHEME**

**SUBJECT: TECHNICAL DRAWING**

**PROFICIENCY: TECHNICAL**

**YEAR: ..... CENTRE #: .....**

**CANDIDATE #: ..... TERRITORY: .....**

**NAME OF TEACHER: .....**

**SECTION 2A: PLANE GEOMETRY**

KNOWLEDGE	MARKS		APPLICATION	MARKS		PRACTICAL ABILITY	MARKS	
		Max			Max			Max
Reproducing given information (for example, views, measurements)		4	<ul style="list-style-type: none"> <li>Applying correct principles of geometric construction</li> <li>Linework/linetype</li> </ul>		4 3	<ul style="list-style-type: none"> <li>Accuracy of geometric construction</li> <li>Quality of Line work/line type</li> <li>Dimensions</li> <li>Neatness</li> </ul>		3 2 2 2
		4			7			9

**SECTION 2B: SOLID GEOMETRY**

KNOWLEDGE	MARKS		APPLICATION	MARKS		PRACTICAL ABILITY	MARKS	
		Max			Max			Max
Reproducing given information (for example, views, measurements)		4	<ul style="list-style-type: none"> <li>Applying correct principles of geometric construction</li> <li>Line work/line type</li> </ul>		4 3	<ul style="list-style-type: none"> <li>Accuracy of geometric construction</li> <li>Quality of Line work/line type</li> <li>Dimensions</li> <li>Neatness</li> </ul>		3 2 2 2
		4			7			9

**TOTAL MARKS**

KNOWLEDGE	MARKS	APPLICATION	MARKS	PRACTICAL ABILITY	MARKS
	8		14		18



**CARIBBEAN EXAMINATIONS COUNCIL  
SCHOOL-BASED ASSESSMENT  
MARK SCHEME**

**SUBJECT: TECHNICAL DRAWING**

**PROFICIENCY: TECHNICAL**

**YEAR: .....**

**CENTRE #: .....**

**CANDIDATE #: .....**      **TERRITORY: .....**

**NAME OF TEACHER: .....**

**SECTION 3: BUILDING DRAWING**

KNOWLEDGE	MARKS		APPLICATION	MARKS		PRACTICAL ABILITY	MARKS	
		Max			Max			Max
Knowledge of:			Principles of:			Practicality of:		
<i>Entrepreneurship Opportunities - Small Business Plan:</i> <ul style="list-style-type: none"> <li>• Organisation of Portfolio</li> <li>• Statement of the problem</li> <li>• Conditions</li> <li>• Design principles</li> </ul>		3	<i>Entrepreneurship Opportunities/Small Business Plan:</i> <ul style="list-style-type: none"> <li>• Organisation of Portfolio</li> <li>• Statement of the problem</li> <li>• Conditions</li> <li>• Design principles</li> </ul>		7	<i>Design</i> <ul style="list-style-type: none"> <li>• Originality</li> <li>• Functionality</li> <li>• Suitability</li> <li>• Conformity to building standards</li> </ul>		7
Working Drawings		2	Working drawings		5	Working drawings <ul style="list-style-type: none"> <li>• Floor Plan</li> <li>• Foundation plan/Roof plan/Details</li> <li>• Elevations</li> <li>• Sectional Elevations</li> </ul>		6 4 4 5
			Design <ul style="list-style-type: none"> <li>• Functionality</li> <li>• Suitability of materials</li> <li>• Conforming to building standards</li> </ul>		2 2 2			
						Dimensions		4
						Dimensioning		4
			Dimensioning		2	Techniques <ul style="list-style-type: none"> <li>• Line work/Quality</li> <li>• Lettering</li> <li>• Symbols</li> </ul>		4 2 2
						Neatness/Presentation		3
		5			20			45



**CARIBBEAN EXAMINATIONS COUNCIL  
SCHOOL-BASED ASSESSMENT  
MARK SCHEME**

**SUBJECT: TECHNICAL DRAWING**

**PROFICIENCY: TECHNICAL**

**YEAR: ..... CENTRE #: .....**

**CANDIDATE #: ..... TERRITORY: .....**

**NAME OF TEACHER: .....**

**SECTION 4: MECHANICAL DRAWING**

KNOWLEDGE	MARKS		APPLICATION	MARKS		PRACTICAL ABILITY	MARKS	
		Max			Max			Max
Knowledge of:			Principles of:			Accuracy of:		
<i>Entrepreneurship Opportunities - Small Business Plan:</i> <ul style="list-style-type: none"> <li>• Organisation of Portfolio</li> <li>• Statement of the problem</li> <li>• Conditions</li> <li>• Design principles Statement of the problem</li> </ul>		3	<i>Entrepreneurship Opportunities - Small Business Plan:</i> <ul style="list-style-type: none"> <li>• Organisation of Portfolio</li> <li>• Statement of the problem</li> <li>• Conditions</li> <li>• Design principles</li> </ul>		7	<i>Design</i> <ul style="list-style-type: none"> <li>• Originality</li> <li>• Functionality</li> <li>• Suitability</li> <li>• Conformity to BS International standards/ISO 9000</li> <li>• Design</li> </ul>		7
Working Drawings		2	Working Drawings <ul style="list-style-type: none"> <li>• Parts sheet</li> <li>• Pictorial</li> <li>• Sectional view of the assembly</li> <li>• Elevation/Plan of the assembly</li> <li>• Parts list</li> </ul>		5	Working Drawings <ul style="list-style-type: none"> <li>• Parts sheet</li> <li>• Pictorial</li> <li>• Sectional view of the assembly</li> <li>• Elevation/Plan of the assembly</li> <li>• Parts list</li> </ul>		5 3 6 5 2
			Design <ul style="list-style-type: none"> <li>• Function</li> <li>• Safety</li> <li>• Suitability of materials</li> </ul>		2 2 2	Dimensions Dimensioning Techniques		4 2





KNOWLEDGE (cont'd)	MARKS		APPLICATION (cont'd)	MARKS		PRACTICAL ABILITY (cont'd)	MARKS	
		Max			Max			Max
Knowledge of:			Principles of:			Accuracy of:		
						Line work/Line types <ul style="list-style-type: none"> <li>• Outline</li> <li>• Centre Line</li> <li>• Hidden Line</li> <li>• Section Line</li> </ul>		4
			Dimensioning		2	Text/Print <ul style="list-style-type: none"> <li>• Name of Project</li> <li>• Projection symbols</li> </ul>		2 2
						Neatness/CAD presentation		3
		<b>5</b>			<b>20</b>			<b>45</b>

### Portfolio Development Guidelines

A portfolio is an organised convenient means of collection and presentation of materials which records and verifies a candidate's learning achievements and relates them to the depth and breadth of work required by each unit of the occupational standards. The depth and breadth of work should include a diversity of exhibits which reflects the following **criteria**:

- Writing, Reading and Comprehension Skills
- Critical Thinking and Problem Solving Skills
- Technology Skills
- Practical Skills
- Teamwork Skills

The outline of the portfolio should include information under the following headings:

- Cover Page
- Title Page
- Table of Contents
- Introduction
- Supporting Evidence (Depth & Breadth of Work)
- Self Assessment/Reflection

#### **Details of EACH Heading**

##### **Cover Page**

- Name of School
- Occupational Area CVQ Level 1
- Assessors Name
- Candidate's Name
- Year

##### **Title Page**

- Caribbean Vocational Qualification
- CVQ Level 1
- Occupational Area
- Year

##### **Table of Contents**

- By units
- Number pages

##### **Introduction**

- Portfolio of candidate to include personal data, background information on education / training experiences and expectations.

## **Supporting Evidence**

Provides information on the key formative and summative assignments / projects undertaken by the candidates to achieve the performance criteria in each unit on the Occupational Standards. All evidence supplied by the candidate should be reviewed by the assessor using the **criteria given**. **Evidence must be signed and dated on the date of the review by the assessor.**

### **Suggestions for supporting evidence:**

- Written Assignment
- Oral Questions (checklist format)
- Projects
- Work Samples
- Research Assignments
- Fieldtrip reports
- Summative evaluation of practical work
- Digital photographs of candidates performing critical tasks

### **Self-Assessment/Reflections**

Allows candidates to rate their performance against the requirements of the relevant unit/s of competency and allows candidates to reflect in writing whether their expectations have been achieved in the particular occupational area.

### **Summary**

*Each candidate* in every occupational area *must* prepare a portfolio which will showcase:

- Growth and development of the candidate during the two year period.

Portfolios *must* be kept for evaluation by the Internal Verifier, External Verifier and the Quality Assurance auditor of the Caribbean Examination Council.

**GUIDELINES FOR THE DELIVERY AND ASSESSMENT OF THE SCHOOL-BASED ASSESSMENT USING THE PRINCIPLES OF COMPETENCY BASED EDUCATION, TRAINING AND ASSESSMENT (CBETA)**

*An Internal Verifier is recommended for the Technical Drawing Course. This is an internal person in the institutions responsible for ensuring the quality of the delivery and assessment of all the Sections of the Syllabus and the CVQ Units of Competence for the SBA and the SBA portfolio. The internal verifier assists the teachers/facilitators in the preparation of the delivery and assessment schedules; monitor the progress of portfolios as well as teachers/facilitators and students' record keeping. They support and work at ensuring accuracy and consistency and effectiveness of the learning experiences. They work collaboratively with the external verifiers assigned to the institutions.*

*Principals or other administrative personnel and teachers/facilitators are encouraged to use the following guidelines in achieving the requirements for the award of the Level 1 CVQ Unit Certification required for the SBA.*

1. *Prior to the commencement of delivery of the syllabus:*
  - (a) *access the Regional Occupational Standards to which this syllabus is aligned from the CANTA website ([www.cantaonline.org](http://www.cantaonline.org));*
  - (b) *verify if there are trained external verifiers available;*
  - (c) *ensure that teachers/facilitators are trained assessors;*
  - (d) *ensure that internal verifiers are trained;*
  - (e) *clarify all concerns about the CVQ, relevant procedures and documentation required for the training, delivery, assessment and verification processes and final documents required for submission to CXC.*
2. *Place substantial reliance on evidence to make judgements on the quality of students' performance;*
3. *Engage in a flexible schedule of continuous teaching and assessment until mastery of competency is demonstrated. The assessment is an integral part of the learning process as well as a means of evaluating it;*
4. *Maintain evidence of students' learning through the use of the internal and external verification systems required for the delivery and assessment of the CVQ.*

**PORTFOLIO ASSESSMENT**

*The portfolio is a student-centred communication approach that adequately reflects the teaching and learning experiences through authentic activities. This assessment provides teachers/facilitators with an opportunity to participate in the progress of the students in a very broad context. This may include the observation of the students in exploring, experimenting, taking risks, developing creative solutions and learning to access or make judgements (competent or developing competency) about their own performances. The portfolio places a high premium on quality. It provides a strong*



*feedback loop of continuous evaluation and improvement in teaching and learning. It is one of the major quality assurance vehicles for the provision of tangible and intangible evidences, attesting to the quality (relevance, validity, reliability) of educational delivery, assessment and outputs.*

*Portfolio Assessment is multi-dimensional in nature and has the following characteristics of quality:*

- 1. It is continuous and ongoing; providing both formative and summative evaluation opportunities for monitoring the students' progress while they work toward the achievement of the performance outcomes.*
- 2. It uses a wide variety of tangible and intangible evidences (practical and written), reflecting various aspects of the delivery and learning processes.*
- 3. It is reflective, providing students with an opportunity to analyse their performance and track the development of their competencies.*
- 4. The assessment results are used to improve the delivery and learning processes.*
- 5. Contains evidence that represent a variety of assessment methods.*
- 6. Contains the results of assessments of students' work.*

#### **PLANNING THE PORTFOLIO AND ITS EVALUATION**

*This is a collaborative activity between the teachers/facilitators, students and the verification personnel.*

##### Steps

- 1. Discuss with the students the importance of the portfolio as a means of monitoring, evaluating and making judgment on their progress.*
- 2. Select the entries for the portfolio and establish criteria for its storage and maintenance. Encourage the use of electronic portfolios.*
- 3. Outline and monitor the organisation of the evidence (cover page, table of contents, logical building and exhibition of the artefacts a sequence of the units, literary work, student evaluation, reflection or self-assessment statement and others). (See Appendix 2 for Portfolio Development Guidelines)*
- 4. Develop a completion and evaluation schedule for the portfolio. This is important for enabling completion and recognition of the CVQ Units of Competence. This is a joint activity among the students, teachers/facilitators, internal verifier and external verifier/s and the quality assurance personnel from CXC.*

**Western Zone Office**  
**1 April 2015**



# CARIBBEAN EXAMINATIONS COUNCIL

Caribbean Secondary Education Certificate®



## TECHNICAL DRAWING

### Specimen Papers and Mark Schemes/Keys

**Specimen Papers:**

- Paper 01
- Paper 02 (Building Drawing)
- Paper 02 (Mechanical Engineering Drawing)

**Mark Schemes and Keys:**

- Paper 01
- Paper 02 (Building Drawing)
- Paper 02 (Mechanical Engineering Drawing)



CARIBBEAN EXAMINATIONS COUNCIL  
CARIBBEAN SECONDARY EDUCATION CERTIFICATE®  
EXAMINATION

TECHNICAL DRAWING

Paper 01 – General Proficiency

75 minutes

READ THE FOLLOWING INSTRUCTIONS CAREFULLY.

1. This test consists of 60 items. You will have 75 minutes to answer them.
2. In addition to this test booklet, you should have an answer sheet.
3. Each item in this test has four suggested answers lettered (A), (B), (C), (D). Read each item you are about to answer and decide which choice is best.
4. On your answer sheet, find the number which corresponds to your item and shade the space having the same letter as the answer you have chosen. Look at the sample item below.

Sample Item

In drawings, thin short dashes represent

- (A) adjacent parts
- (B) hidden details
- (C) movable parts
- (D) irregular details

Sample Answer



The best answer to this item is “hidden details,” so (B) has been shaded.

5. If you want to change your answer, erase it completely before you fill in your new choice.
6. When you are told to begin, turn the page and work as quickly and as carefully as you can. If you cannot answer an item, go on to the next one. You may return to that item later.
7. You may do any rough work in this booklet.
8. Figures are not necessarily drawn to scale.

---

**DO NOT TURN THIS PAGE UNTIL YOU ARE TOLD TO DO SO.**

---

1. In an isometric sketch, circles and arcs will appear as

- (A) segments
- (B) round, smooth lines
- (C) ellipses or part of ellipses
- (D) round arcs without distortions

2. Which of the following instruments is used to draw irregular curves?

- (A) Compass
- (B) Protractor
- (C) Flexicurve
- (D) Radius curve

3. Which of the following drawings shows triangles of equal area between parallel lines?

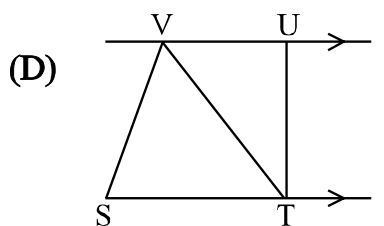
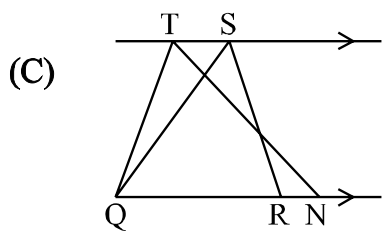
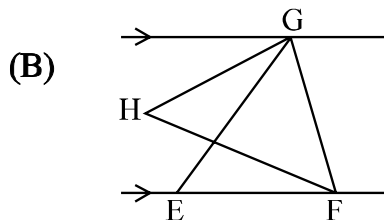
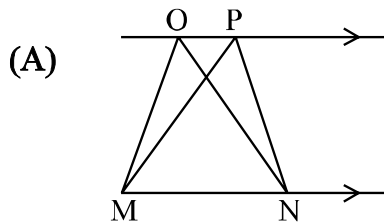

Item 4 refers to the following diagram.

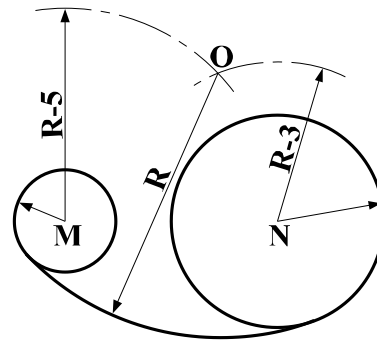

4. In the drawing above, which of the following letters indicates the centre of the arc which is tangential to the two circles?

- (A) M
- (B) N
- (C) O
- (D) R

Item 5 refers to the following views.

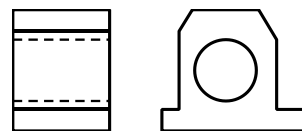

5. Which of the views below shows the plan of the object illustrated in the two views above?

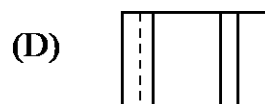
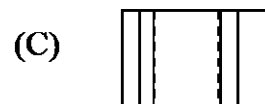
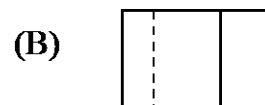
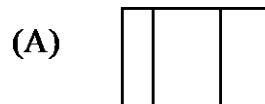



6. Which of the following correctly defines the locus of a point?
- (A) The calculated circumference
  - (B) A point which moves and traces a path
  - (C) The cutting tool attached to the lathe
  - (D) A right-angled triangle wrapped around a cylinder

7. Which of the following circles is correctly dimensioned?

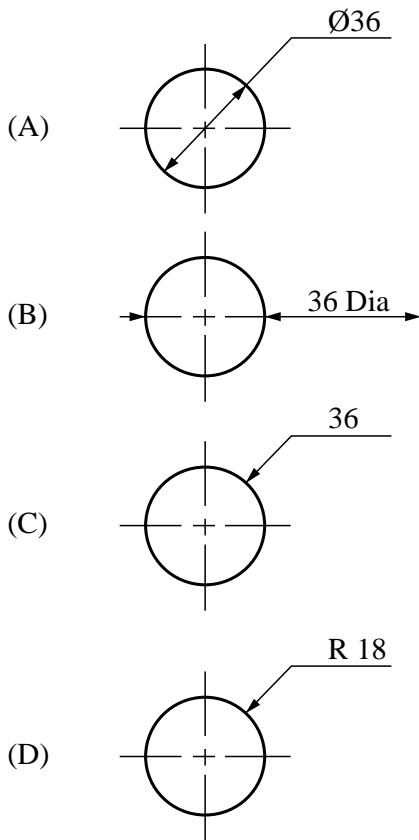

Item 8 refers to the following diagram.

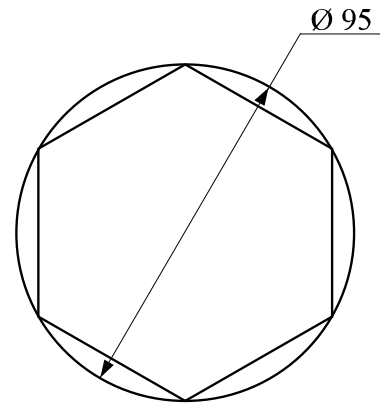

8. The polygon shown above is a regular hexagon of side
- (A) 47.5 mm
  - (B) 50.5 mm
  - (C) 52.5 mm
  - (D) 55.5 mm

Item 9 refers to the following diagram.

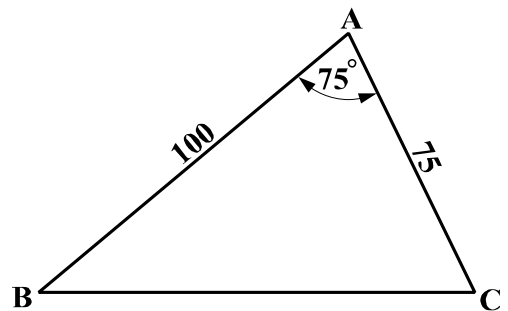

9. The triangle illustrated above can be constructed with the use of
- (A) a ruler and pencil only
  - (B) a compass and protractor only
  - (C) a compass, a ruler and a pencil
  - (D) a set-square, a ruler and protractor

GO ON TO THE NEXT PAGE

10. Which of the following is a view of a right triangular pyramid?

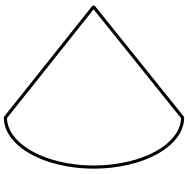
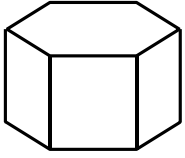
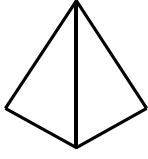
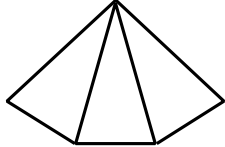
- (A) 
- (B) 
- (C) 
- (D) 

11. Which of the following represents the correct procedure for bisecting an angle of 90°?

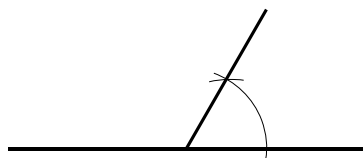
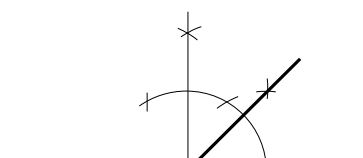
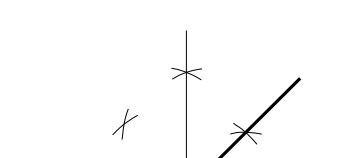
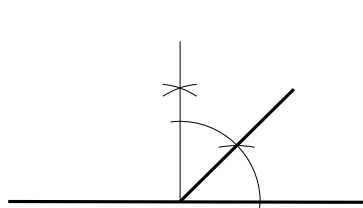
- (A) 
- (B) 
- (C) 
- (D) 

Item 12 refers to the following diagram.

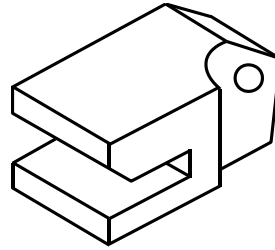

12. Which of the following represents the plan of the drawing above?

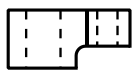
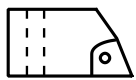
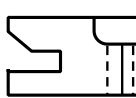
- (A) 
- (B) 
- (C) 
- (D) 

13. Which of the following patterns could be folded to form a truncated square prism having no cover or base?

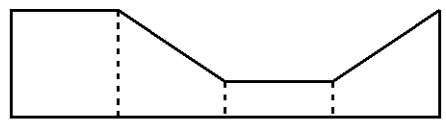
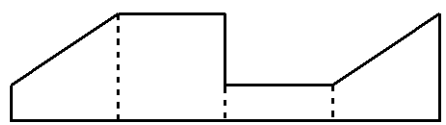
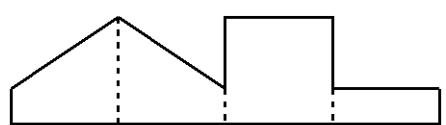
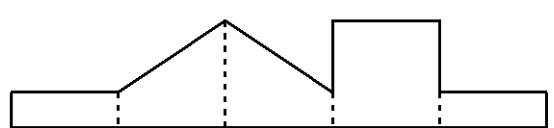
- (A) 
- (B) 
- (C) 
- (D) 

GO ON TO THE NEXT PAGE

14. Which of the following drawings shows a rectangle equal in area to a triangle?

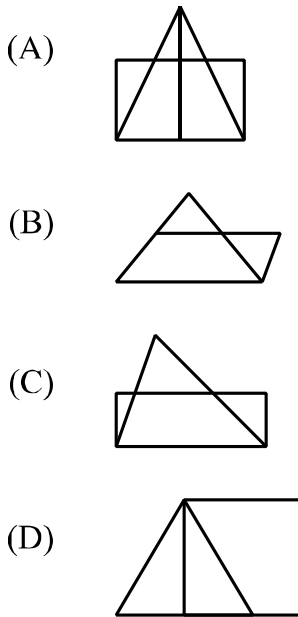

Item 15 refers to the following views.

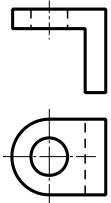

15. Which pictorial view below is represented by the orthographic views shown above?

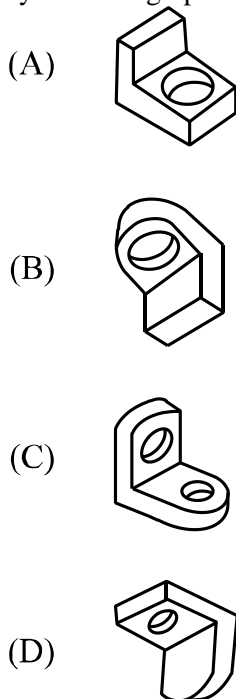

Item 16 refers to the following construction.

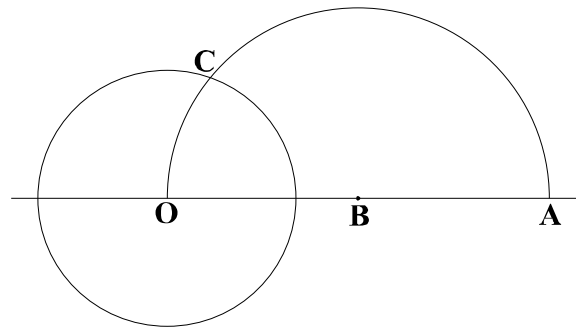

16. The purpose of the construction above, when completed, is to
- (A) draw a tangent to the circle from A
- (B) draw two tangents to the circle from B
- (C) draw an arc to pass through three points
- (D) find the mean proportional to AO and CO

Item 17 refers to the following diagram.

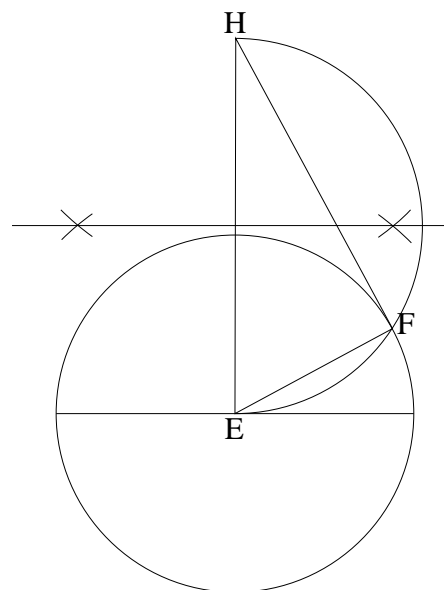

17. In the diagram above, the angle EFH is
- (A)  $30^\circ$
- (B)  $45^\circ$
- (C)  $60^\circ$
- (D)  $90^\circ$

GO ON TO THE NEXT PAGE

18. A cube with an edge of 80 mm is to be drawn in oblique projection. The length of the receding lines, in mm, should be

- (A) 10
- (B) 20
- (C) 30
- (D) 40

Item 19 refers to the following diagram.

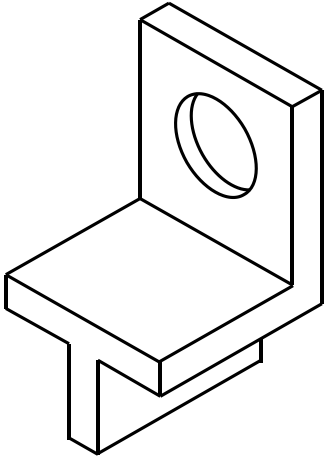

19. Which of the following is a true elevation of the drawing shown above?

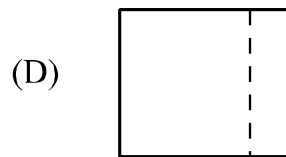
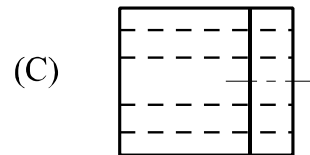
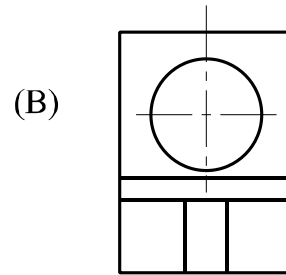
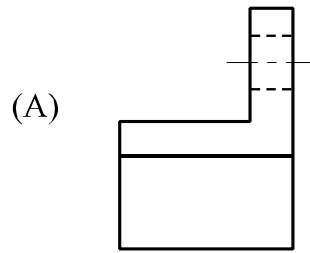

20. Which of the following illustrates the normal of an ellipse?

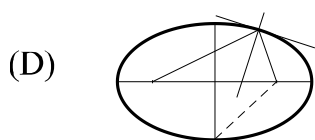
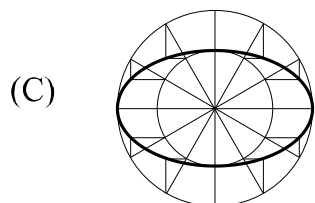
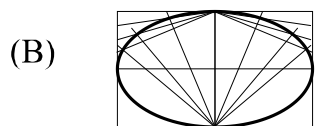
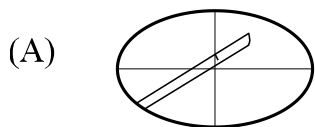

21. 'The spiral of Archimedes' is defined as

- (A) a plane curve generated by a point on a taut chord as it is unwound from the perimeter of a polygon
- (B) the path generated by a point which revolves uniformly about a pole and has a uniform motion away from it
- (C) a plane curve generated by the path of a point on the perimeter of a wheel as the wheel travels on a straight track
- (D) the path generated by a point travelling in a plane such that the difference of its distance from two foci is constant and equal to the transverse axis

22. Which of the following patterns can be folded to form a square prism with an oblique top?

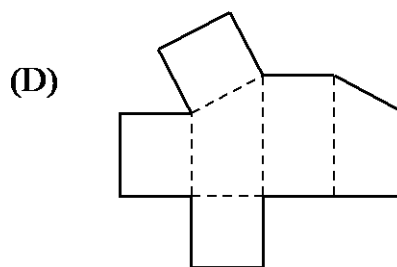
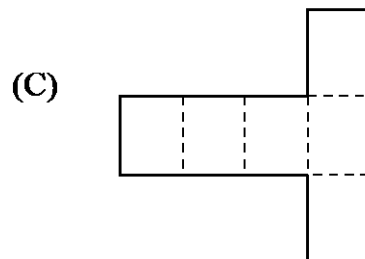
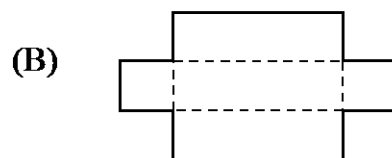
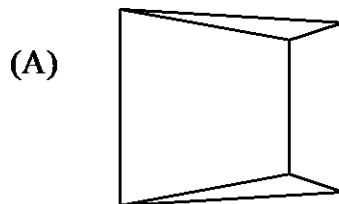

Item 23 refers to the following diagram.

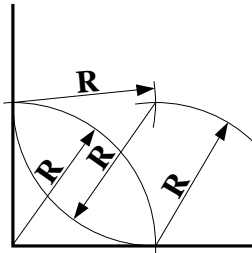

23. The diagram above illustrates the construction of a
- (A) circle tangential to two converging lines
  - (B) tangent from a point outside a given circle
  - (C) circle tangential to two lines at right angles
  - (D) tangent to a circle at a point on its circumference

Item 24 refers to the following diagram.

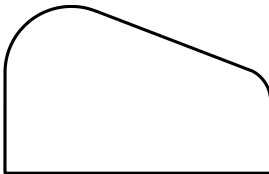

24. The construction used in designing the bending jig illustrated above was that for obtaining a
- (A) tangent joining two arcs
  - (B) common internal tangent
  - (C) tangent to two equal circles
  - (D) tangent from a point outside the circle
25. The point at which the bisectors of the angles of a triangle meet is the centre of
- (A) two given circles
  - (B) the escribed circle
  - (C) the inscribed circle
  - (D) the common tangent

Item 26 refers to the following diagram.

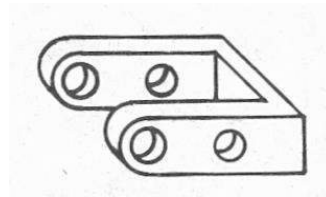

26. The type of projection illustrated above is
- (A) oblique
  - (B) first-angle
  - (C) isometric
  - (D) third-angle

Item 27 refers to the following construction.

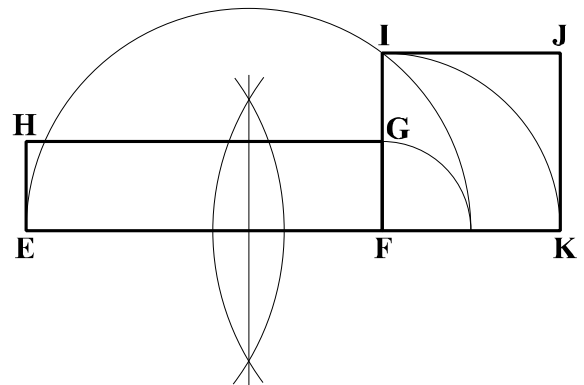

27. Which of the following is TRUE of the construction above?
- (A) IJKF is half the area of EFGH.
  - (B) EFGH is equal in area to IJKF.
  - (C) EFGH is half the area of IJKF.
  - (D) IJKF is twice the area of EFGH.
28. The ANSI, BS and ISO regulations used in technical drawing are referred to as
- (A) local codes
  - (B) building codes
  - (C) regional standards
  - (D) international standards

GO ON TO THE NEXT PAGE

29. When sketching pictorial figures, one should first

- (A) sketch circles
- (B) draw all straight lines
- (C) construct parts separately
- (D) construct a box to hold the figure

30. Which of the following surfaces is developed in the shape of a 'T' by unfolding or unrolling?

- (A) A square pyramid
- (B) A triangular prism
- (C) A rectangular box with lid
- (D) A hexagonal truncated prism

Item 31 refers to the following construction.

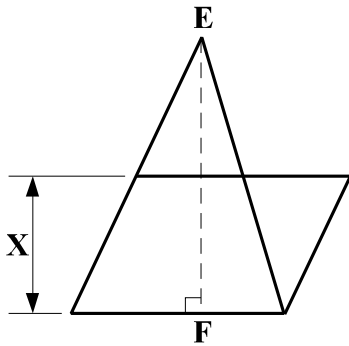

31. The construction above shows how to draw a parallelogram equal in area to a given triangle. If EF is 30, then X is

- (A) 10
- (B) 15
- (C) 20
- (D) 30

Item 32 refers to the following diagram.

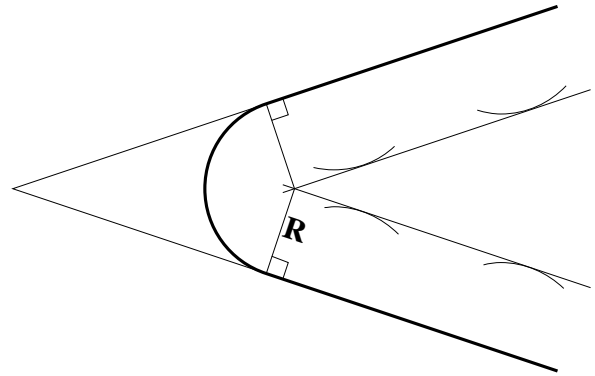

32. The diagram above shows the method of finding the centre of an arc, with radius R, which is tangential to

- (A) two straight lines meeting at right angles
- (B) two straight lines meeting at any angle
- (C) a line and a circle
- (D) a straight line

Item 33 refers to the following diagram.

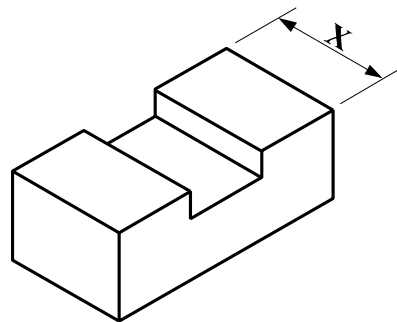

33. The diagram above is to be reproduced in third angle projection. On what views can the distance X be seen?

- (A) Top and front
- (B) Top and right side
- (C) Front and left side
- (D) Front and right side

Item 34 refers to the following diagram.

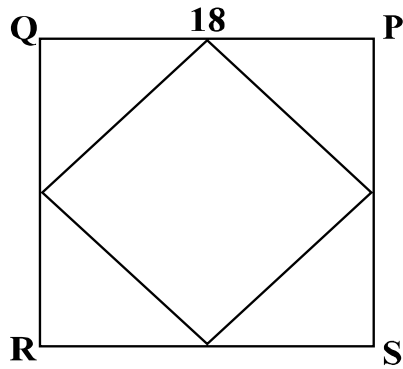

34. The sides of the square QRST above are bisected and the adjacent points are joined to form another square. The area of the new square is
- (A) 72 mm<sup>2</sup>
  - (B) 81 mm<sup>2</sup>
  - (C) 162 mm<sup>2</sup>
  - (D) 324 mm<sup>2</sup>

Item 35 refers to the following diagram.

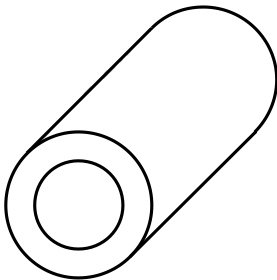

35. In the diagram above, the circles and curves are shown in their true shapes. The method of projection used is
- (A) oblique
  - (B) trimetric
  - (C) isometric
  - (D) orthographic

Item 36 refers to the following diagram.

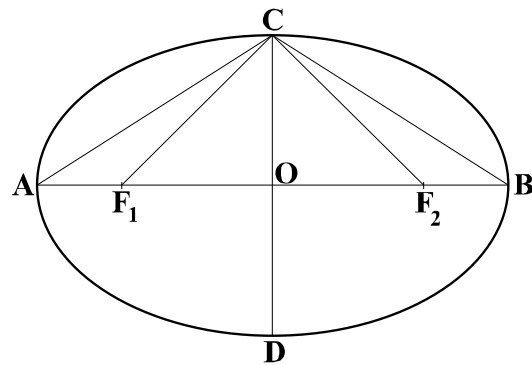

36. In the ellipse above, which sum of distances is equal to AB?
- (A)  $F_1C + F_2C$
  - (B)  $AC + BC$
  - (C)  $F_2C + CD$
  - (D)  $F_1C + CB$
37. When designing a new product, which type of drawing is usually made FIRST?
- (A) Scale
  - (B) Sketch
  - (C) Detail
  - (D) Engineering
38. The centre of the circumscribing circle of a triangle can be found by using the
- (A) three medians
  - (B) bisectors of any two sides
  - (C) bisectors of any two angles
  - (D) perpendicular to any side and a median
39. In a perspective drawing, all vertical lines
- (A) have vanishing points
  - (B) pierce the picture plane
  - (C) are toward the point of sight
  - (D) are parallel to the picture plane



Item 40 refers to the following diagram.

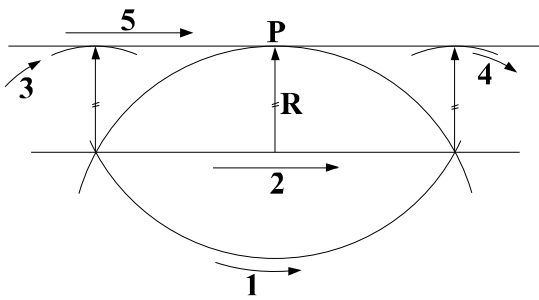

40. The diagram above shows a method of constructing a

- (A) tangent to a circle at a point
- (B) tangent at a point on an arc
- (C) circle passing through a given point
- (D) circle tangential to two converging lines

41. Which of the following scales would be used to produce the smallest drawing of a given object?

- (A) 1:2
- (B) 1:1
- (C) 5:1
- (D) 10:1

Item 42 refers to the following figure.

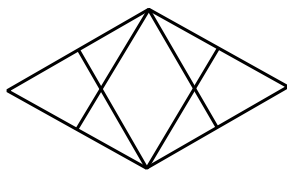

42. The figure above illustrates the start of a method of construction for drawing views of

- (A) circles in perspective drawings
- (B) circles in isometric drawings
- (C) irregular curves in perspective drawings
- (D) irregular curves in orthographic drawings

43. Which of the following drawings represents a truncated prism?

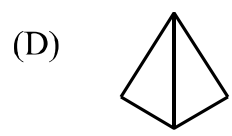
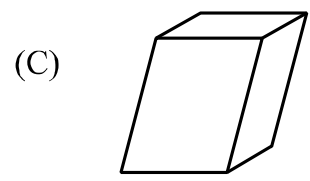
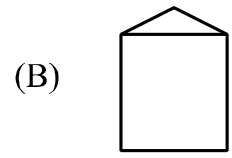
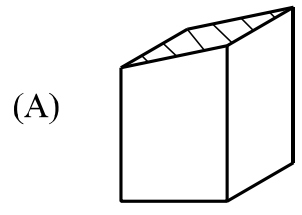

44. On which of the following planes would the plan of an orthographic projection appear?

- (A) Profile
- (B) Vertical
- (C) Auxiliary
- (D) Horizontal

45. Which of the following class of fire extinguishers can be used to put out an electrical fire?

- (A) Class A
- (B) Class B
- (C) Class C
- (D) Class D

Item 46 refers to the following diagram.

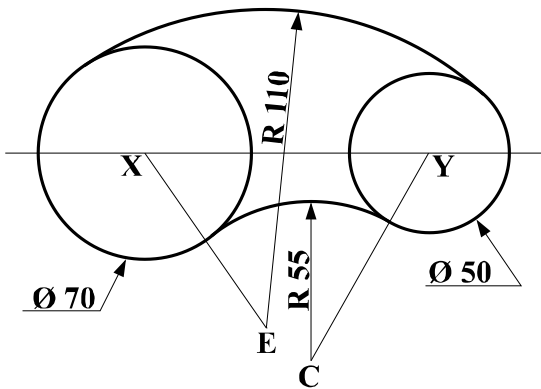

46. In the drawing above, two arcs are drawn tangential to two circles of different radii. What are the lengths of EX and CY respectively?

- (A) 75 and 80
- (B) 80 and 75
- (C) 80 and 105
- (D) 100 and 80

47. The distance between the foci of an ellipse is 24 mm and the length of its minor axis is 18 mm. The length of its major axis, in mm, is

- (A) 26
- (B) 28
- (C) 30
- (D) 32

48. The tolerance for a shaft 18 mm long is +0.055 and -0.063. What is the correct tolerance range?

- (A) 17.045 to 18.063
- (B) 17.055 to 18.063
- (C) 18.055 to 17.937
- (D) 18.550 to 17.937

49. Three circles of varying diameters which touch one another can be drawn if given

- (A) their radii and a line
- (B) two lines and a point
- (C) the position of their centres
- (D) three points through which they pass

50. RS is a straight line. A line segment 25 mm long is marked. Exterior angles of  $45^\circ$  are marked off at each end of the line segment. The two angled lines formed are 25 mm long. If this construction is continued until a closed figure is formed, the figure obtained is

- (A) a pentagon
- (B) a hexagon
- (C) an octagon
- (D) a nonagon

Item 51 refers to the following drawing.

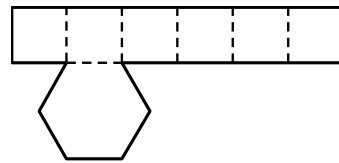

51. The drawing above shows the development of a

- (A) pentagonal box with lid
- (B) hexagonal box with lid
- (C) pentagonal box without lid
- (D) hexagonal box without lid

Item 52 refers to the following elevations.

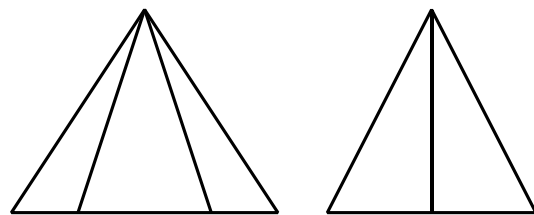

52. The elevations shown above are those of a

- (A) square prism
- (B) square pyramid
- (C) triangular prism
- (D) hexagonal pyramid

53. When a plane figure has a linear reduction only, the

- (A) proportions are changed
- (B) proportions remain the same
- (C) dimensions remain the same
- (D) dimensions and proportions are changed

54. Which of the following drawings represents an escribed circle?

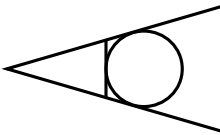
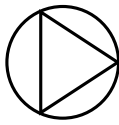
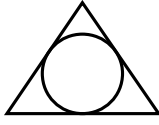
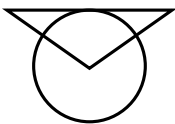
- (A) 
- (B) 
- (C) 
- (D) 

55. Which is the FIRST step that should be taken if a person receives an electric shock in a workshop?

- (A) Turn off the source.
- (B) Activate the fire alarm.
- (C) Remove the person to safety.
- (D) Cover the person with a safety blanket.

Item 56 refers to the following drawing.

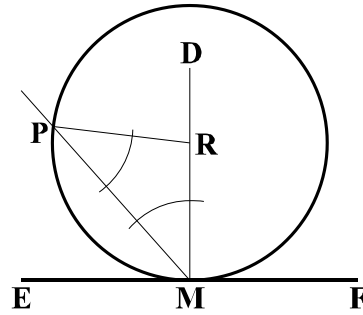

56. In the drawing above, which of the following is NOT true?

- (A) The line RM is equal to the line PR.
- (B) The line DR can be of any length.
- (C) The angle PRM is equal to the angle RPM.
- (D) The angle RMP is equal to the angle RPM.

57. A netball court has a length of 30 m. A line representing this distance on a drawing measures 30 mm. To what scale ratio is the line drawn?

- (A) 1:1000
- (B) 1: 500
- (C) 1: 200
- (D) 1: 100

Item 58 refers to the following drawing.

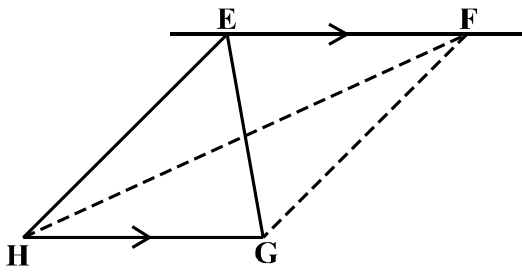

58. Which of the following is TRUE of the drawing above?
- (A) The triangle EGH has been enlarged to a figure which is twice its area.
  - (B) The quadrilateral EFGH has been reduced to a figure having half of its area.
  - (C) The triangles EGH and FGH are equal in area.
  - (D) The quadrilateral EFGH has been changed into a triangle of equal area.

59. Which of the following drawings indicates the correct method of constructing similar triangles?

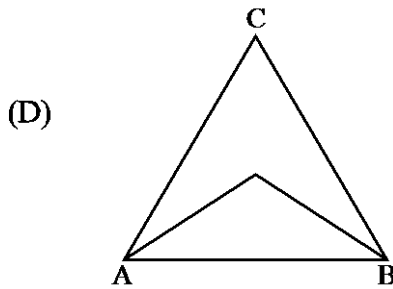
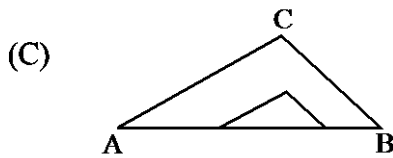
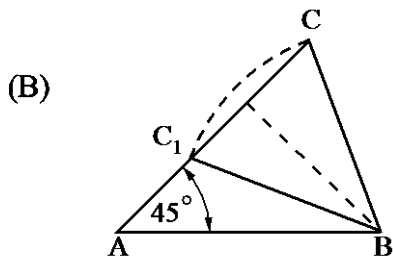
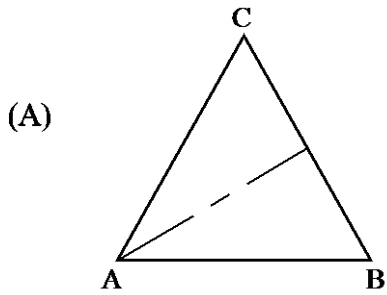

Item 60 refers to the following three views.

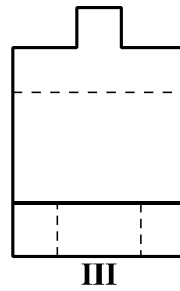
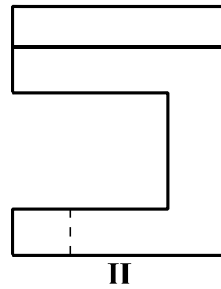
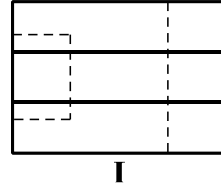

60. The figures above show three views of a block. The front elevation, end view and plan respectively are

- (A) I, III and II  
 (B) II, I and III  
 (C) II, III and I  
 (D) III, II and I

END OF TEST

Item	Key	Syllabus Reference
1	C	2B.1:1.2 (i)
2	C	1.2:2.2
3	A	2A.1:1.1 (iii)
4	C	2A.1:1.2
5	C	2B.1:1.3
6	B	2A.1:1.4
7	A	1.2:2.5
8	A	2A.1:1.1 (v)
9	C	2A.1:1.1 (iii)
10	C	2B.1:1.5
11	B	2A.1:1.1 (ii)
12	B	2B.1:1.3
13	A	2B.1:1.8
14	C	2A.1:1.5
15	B	2B.1:1.1
16	A	2A.1:1.2
17	D	2A.1:1.2
18	D	2B.1:1.2 (ii)
19	A	2B.1:1.3
20	D	2A.1:1.3
21	B	2A.1:1.3
22	D	2B.1:1.8
23	C	2A.1:1.2
24	A	2A.1:1.2
25	C	2A.1:1.1 (vi)
26	A	2B.1:1.2 (ii)
27	B	2A.1:1.6
28	D	1.2:2.1
29	D	2B.1:1.1
30	C	2B.1:1.8
31	B	2A.1:1.6
32	B	2A.1:1.2
33	B	2B.1:1.3
34	C	2A.1:1.1 (iv)
35	A	2B.1:1.2 (ii)
36	A	2A.1:1.3
37	B	1.3:3.1
38	B	2A.1:1.1 (vi)
39	D	2B.1:1.2 (iii)
40	B	2A.1:1.2
41	A	1.2:2.6
42	B	2B.1:1.2 (i)
43	A	2B.1:1.5
44	D	2B.1:1.3
45	C	1.1:1.4
46	A	2A.1:1.2
47	C	2A.1:1.3
48	C	1.2:2.5
49	B	2A.1:1.1 (vi)

<b>Item</b>	<b>Key</b>	<b>Syllabus Reference</b>
50	C	2A.1:1.1 (v)
51	D	2B.1:1.8
52	D	2B.1:1.3
53	B	2A.1:1.7
54	A	2A.1:1.1 (vi)
55	B	1.1:1.6
56	C	2A.1:1.1 (vi)
57	A	1.2:2.6
58	C	2A.1:1.1 (iii)
59	C	2A.1:1.1 (iii)
60	C	2B.1:1.3



TEST CODE **01267020**

**SPEC 2015/01267020**

**C A R I B B E A N E X A M I N A T I O N S C O U N C I L**

**CARIBBEAN SECONDARY EDUCATION CERTIFICATE®  
EXAMINATION**

**TECHNICAL DRAWING – MECHANICAL ENGINEERING DRAWING**

**SPECIMEN PAPER**

**Paper 02 – General Proficiency**

*2 hours 40 minutes*

**GENERAL INFORMATION**

1. Each candidate should have the following for this examination:

Traditional Drawing Method

Two sheets of drawing paper (both sides may be used)  
Drawing instruments  
Drawing board and T-square  
Metric scale rule

Computer-Aided Drafting Method

A minimum of six sheets of size 8½" × 11" OR three sheets of size 11" × 17" paper  
Personal computer with monitor, keyboard, mouse and printer  
Computer-Aided Drafting software

**N.B.** ALL solutions to questions attempted for this Option **MUST** be **PRINTED** for submission.

2. All dimensions are given in millimetres unless otherwise stated.
3. When first-angle or third-angle is not specified, the choice of projection is left to the candidate's discretion, in which case the type of projection used **MUST** be clearly stated.
4. Where scales to be employed are not stated, the full size should be applied.
5. The candidate should use his/her own judgement to supply any dimension or detail not directly shown on the drawings.
6. The number of each question answered **MUST** be written next to the solution.
7. Each candidate **MUST** enter his/her school code and registration number in the appropriate space at the bottom right-hand corner of the drawing paper.
8. All geometrical construction lines **MUST** be visible on all answers submitted for **BOTH** Traditional Drawing and Computer-Aided Drafting methods.
9. You are advised to spend 10 minutes to read through the paper and plan your answers.

---

**DO NOT TURN THIS PAGE UNTIL YOU ARE TOLD TO DO SO.**

Copyright © 2012 Caribbean Examinations Council  
All rights reserved.



**This paper consists of TWO questions divided into two sections: Section I, Assembly Drawing and Section II, Sketch and Design. Answer ALL questions.**

**SECTION I – ASSEMBLY DRAWING**

**Do NOT spend more than 2 hours on this section.**

1. Figure 1, on the enclosed sheet, shows the first-angle orthographic projection details of the parts that make up a Hinge Assembly. In assembly, part (2), the leaf, is fitted over part (1), the base, and is set at right angle ( $90^0$ ) to it. The parts are fixed by the pin bolt, part (3), and secured by the pin nut, part (4).
- (a) Draw, FULL SIZE, in either first-angle or third-angle orthographic projection, the following views of the assembled parts:
- i. A Plan. Show all hidden details.
  - ii. A full sectional front elevation on cutting plane 'AA'.
- (b) Show SIX main dimensions to include a length, a diameter, a radius and a metric screw thread specification.
- (c) Print the title 'Hinge Assembly' and the scale used. Show the projection method used by symbol.

**NOTE: All fillet radii are 3 mm.**

**[Total 90 marks]**

**SECTION II – SKETCH AND DESIGN**

2. Figure 2 illustrates a simplified method of the sketch of the elevation of a bracket bolted to a frame. The bracket is to be secured using an M12 bolt. Copy the given view inserting the bolt to secure the bracket to the frame. Show ALL constructions for the bolt.

**[Total 30 marks]**

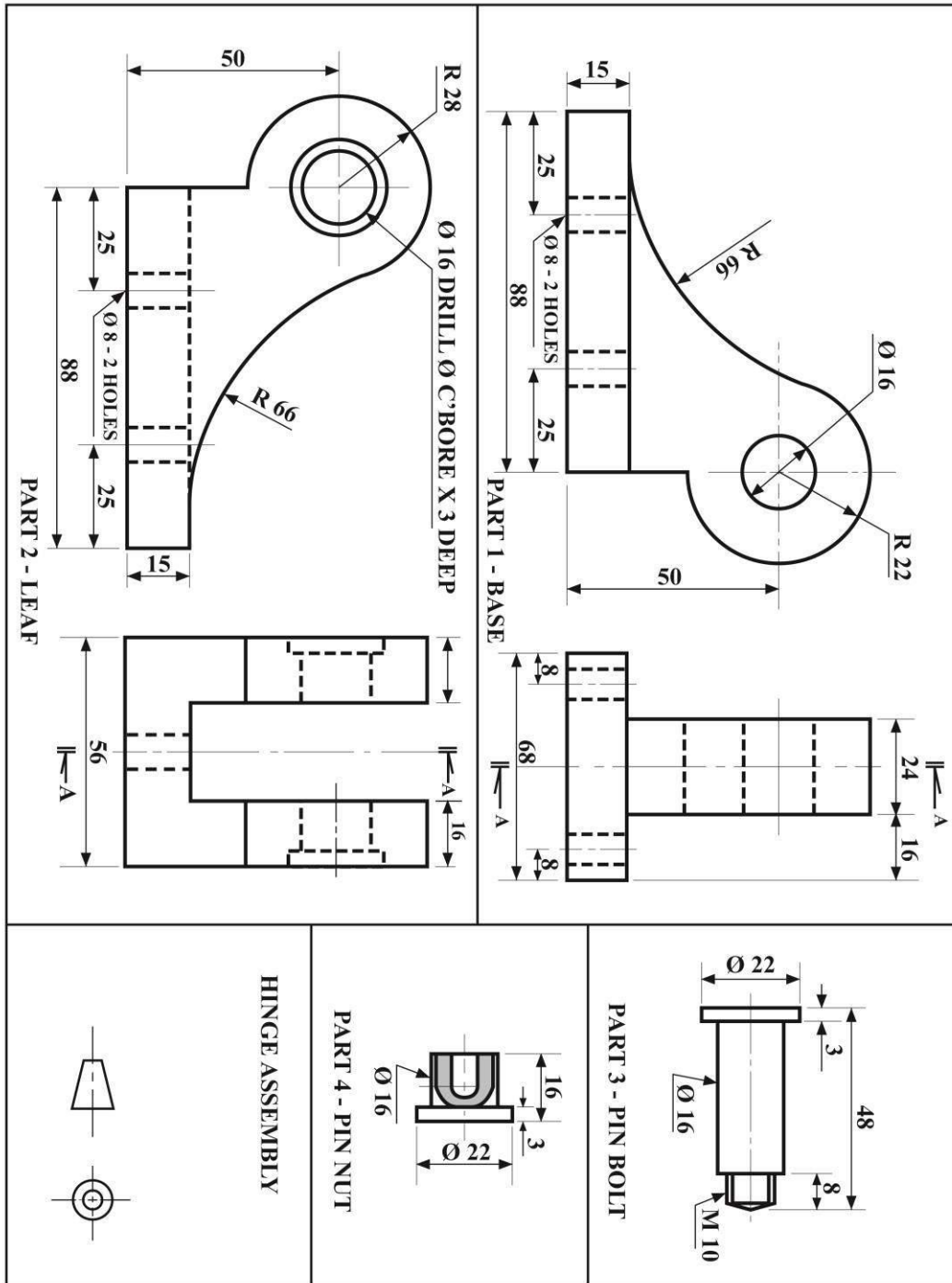
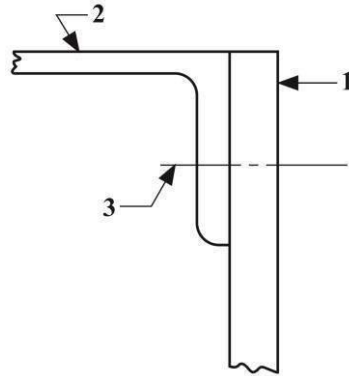

Figure 1



**Figure 2**

**PARTS LIST:**

- 1 – Frame (approximately 15 mm thick)**
- 2 – Bracket (approximately 15 mm thick)**
- 3 – Hexagonal nut**

**END OF TEST**



C A R I B B E A N            E X A M I N A T I O N S            C O U N C I L

CARIBBEAN SECONDARY EDUCATION CERTIFICATE®  
EXAMINATION

TECHNICAL DRAWING

PAPER 02 - GENERAL PROFICIENCY

OPTION - MECHANICAL ENGINEERING DRAWING

SOLUTIONS AND MARK SCHEME

SPECIMEN PAPER 2015

**Note: Scoring methods used are the global/holistic method and analytical method.**

TECHNICAL DRAWING  
PAPER 02  
OPTION – MECHANICAL ENGINEERING DRAWING  
SOLUTIONS AND MARK SCHEME

QUESTION	KNOWLEDGE	MARKS	APPLICATION	MARKS	PRACTICAL ABILITY	MARKS
1	Knowledge of: <ul style="list-style-type: none"> <li>- Orthographic projection (position of views, alignment of details)</li> <li>- Assembly (plan and sectional elevation)</li> <li>- Details of fasteners (screw thread and nut)</li> <li>- Dimensioning</li> <li>- Conventional symbols (cutting plane, centre line)</li> <li>- Hidden details</li> </ul>	5  5  2  2  2  2	Principles of: <ul style="list-style-type: none"> <li>- Orthographic projection (position of views, alignment of details)</li> <li>- Assembly (plan and sectional elevation)</li> <li>- Cross-hatching (to show different parts)</li> <li>- Fasteners</li> <li>- Dimensioning</li> <li>- Conventional symbols (centre line, cutting plane)</li> <li>- Hidden details</li> </ul>	8  10  4  4  3  4  3	Accuracy of: <ul style="list-style-type: none"> <li>- Orthographic projection (position of views, alignment of details)</li> <li>- Assembly (plan and sectional elevation)</li> <li>- Sectional details</li> <li>- Dimensions</li> <li>- Dimensioning techniques</li> </ul> Printing: <ul style="list-style-type: none"> <li>- Title</li> <li>- Scale</li> <li>- Projection method (symbol)</li> <li>- Neatness/CAD presentation</li> <li>- Line work/line type</li> </ul>	8  8  5  4  4  1 1 1 2 2
		<b>18</b>		<b>36</b>		<b>36</b>

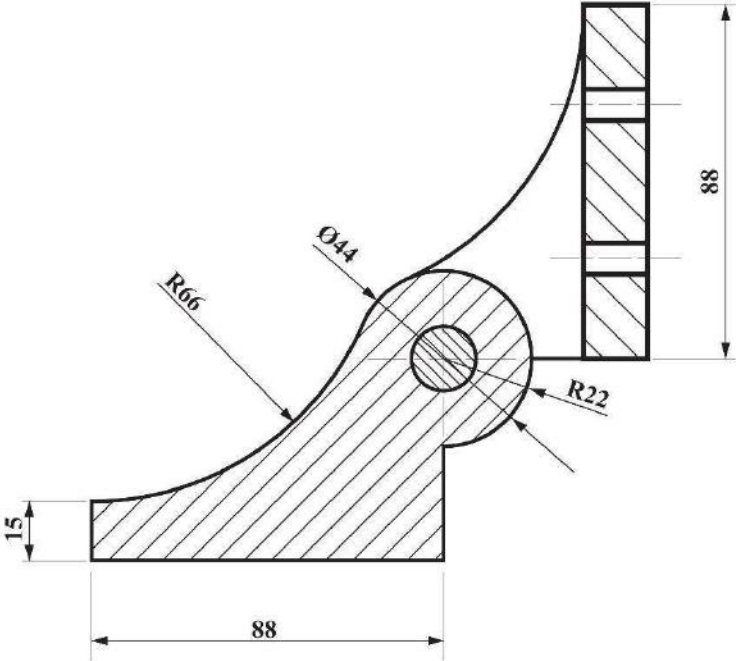

SECTIONAL ELEVATION A - A

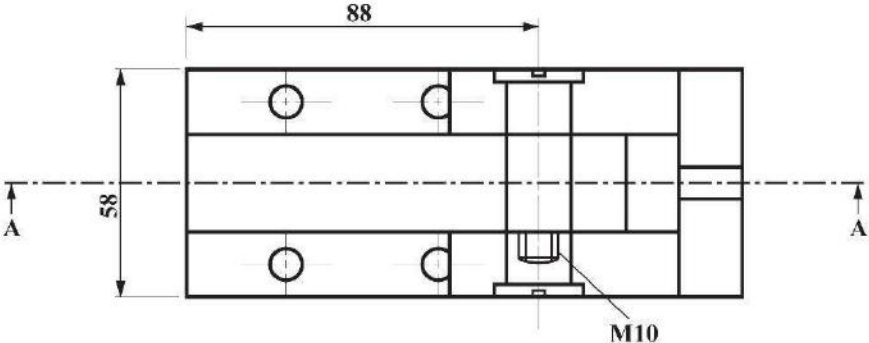

HINGE ASSEMBLY

SOLUTION TO QUESTION 1

TECHNICAL DRAWING  
PAPER 02  
OPTION – MECHANICAL ENGINEERING DRAWING  
SOLUTIONS AND MARK SCHEME

QUESTION	KNOWLEDGE	MARKS	APPLICATION	MARKS	PRACTICAL ABILITY	MARKS
2	Knowledge of: <ul style="list-style-type: none"> <li>- Orthographic projection:               <ul style="list-style-type: none"> <li>• Given view</li> </ul> </li> <li>- Construction of bolt</li> </ul>	2  4	Principles of: <ul style="list-style-type: none"> <li>- Orthographic projection:               <ul style="list-style-type: none"> <li>• Given view</li> </ul> </li> <li>- Construction of bolt               <ul style="list-style-type: none"> <li>• Bolt</li> </ul> </li> <li>- Dimensions</li> </ul>	3  5  3	Accuracy of: <ul style="list-style-type: none"> <li>- Orthographic projection               <ul style="list-style-type: none"> <li>• Given view</li> </ul> </li> <li>- Construction of:               <ul style="list-style-type: none"> <li>• Bolt</li> </ul> </li> <li>- Dimensions</li> <li>- Neatness/CAD presentation</li> </ul>	3  5  3  2
		4		11		13



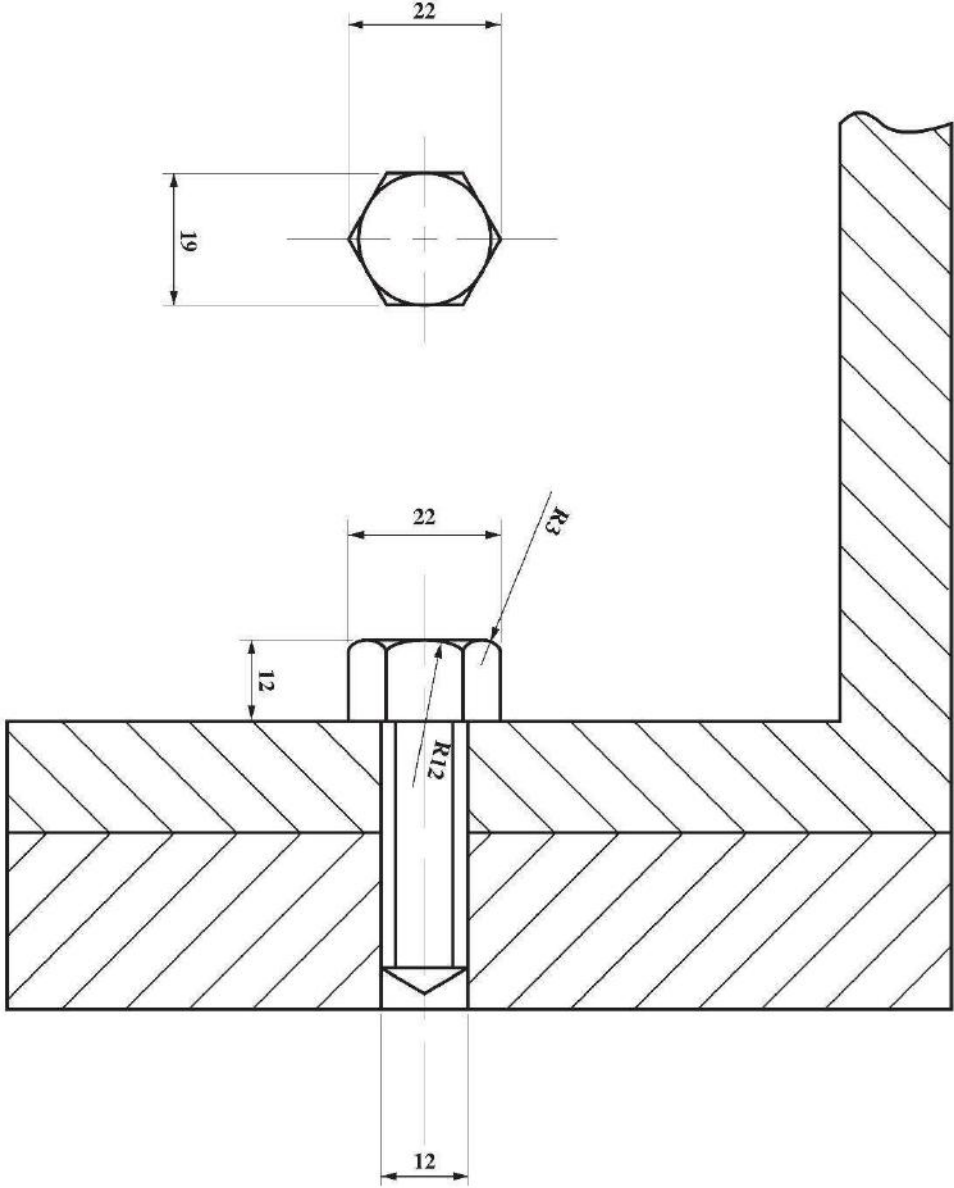



C A R I B B E A N E X A M I N A T I O N S C O U N C I L

CARIBBEAN SECONDARY EDUCATION CERTIFICATE®  
EXAMINATION

TECHNICAL DRAWING – BUILDING DRAWING

SPECIMEN PAPER

Paper 02 – General Proficiency

*2 hours 40 minutes*

GENERAL INFORMATION

1. Each candidate should have the following for this examination:

Traditional Drawing Method

Two sheets of drawing paper (both sides may be used)  
Drawing instruments  
Drawing board and T-square  
Metric scale rule

Computer-Aided Drafting Method

A minimum of six sheets of size 8½" × 11" OR three sheets of size 11" × 17" paper  
Personal computer with monitor, keyboard, mouse and printer  
Computer-Aided Drafting software

**N.B.** ALL solutions to questions attempted for this Option MUST be PRINTED for submission.

2. All dimensions are given in millimetres unless otherwise stated.
3. When first-angle or third-angle is not specified, the choice of projection is left to the candidate's discretion, in which case the type of projection used MUST be clearly stated.
4. Where scales to be employed are not stated, the full size should be applied.
5. The candidate should use his/her own judgement to supply any dimension or detail not directly shown on the drawings.
6. The number of each question answered MUST be written next to the solution.
7. Each candidate MUST enter his/her school code and registration number in the appropriate space at the bottom right-hand corner of the drawing paper.
8. All geometrical construction lines MUST be visible on all answers submitted for BOTH Traditional Drawing and Computer-Aided Drafting methods.
9. You are advised to take some time to read through the paper and plan your answers.

---

**DO NOT TURN THIS PAGE UNTIL YOU ARE TOLD TO DO SO**

**This paper consists of TWO questions divided into two sections: Section I, Working Drawing and Section 2, Sketch and Design. Answer ALL questions.**

### **SECTION I – WORKING DRAWING**

**Do NOT spend more than 2 hours on this section.**

**1.** Figure 1, on the enclosed sheet, shows a single line outline of the floor plan for a three-bedroom residential structure of block construction. The outline of a continuous sloped roof is shown in broken lines.

(a) Draw, to a scale of 1:50, the roof framing plan for the building, showing clearly the following:

- (i) Building line
- (ii) Layout for the ridge, rafters and laths, showing the thickness of the framing members
- (iii) Overhang (eave)

(b) Label the drawing and give the size of each member.

(c) Print the title 'Roof Framing Plan' and state the scale used.

**NOTE: Thickness of roof members must be shown on the roof plan.**

#### **Specifications for roof:**

Common rafters – 50 mm x 50 mm at 600 mm centre to centre

Ridge – 50 mm x 200 mm

Covering material – asphalt shingles on 19 mm plywood

Close boarding – 19 mm thick tongue and groove boards

Fascia – 31 mm thick x 250 mm

External walls – 170 mm thick

Internal walls – 120 mm thick

Wall plate – 100 mm x 100 mm

**[Total 90 marks]**

**GO ON TO THE NEXT PAGE**

SECTION II – SKETCH AND DESIGN

2. The single line floor plan in Figure 1 shows a circle marked 'A'.

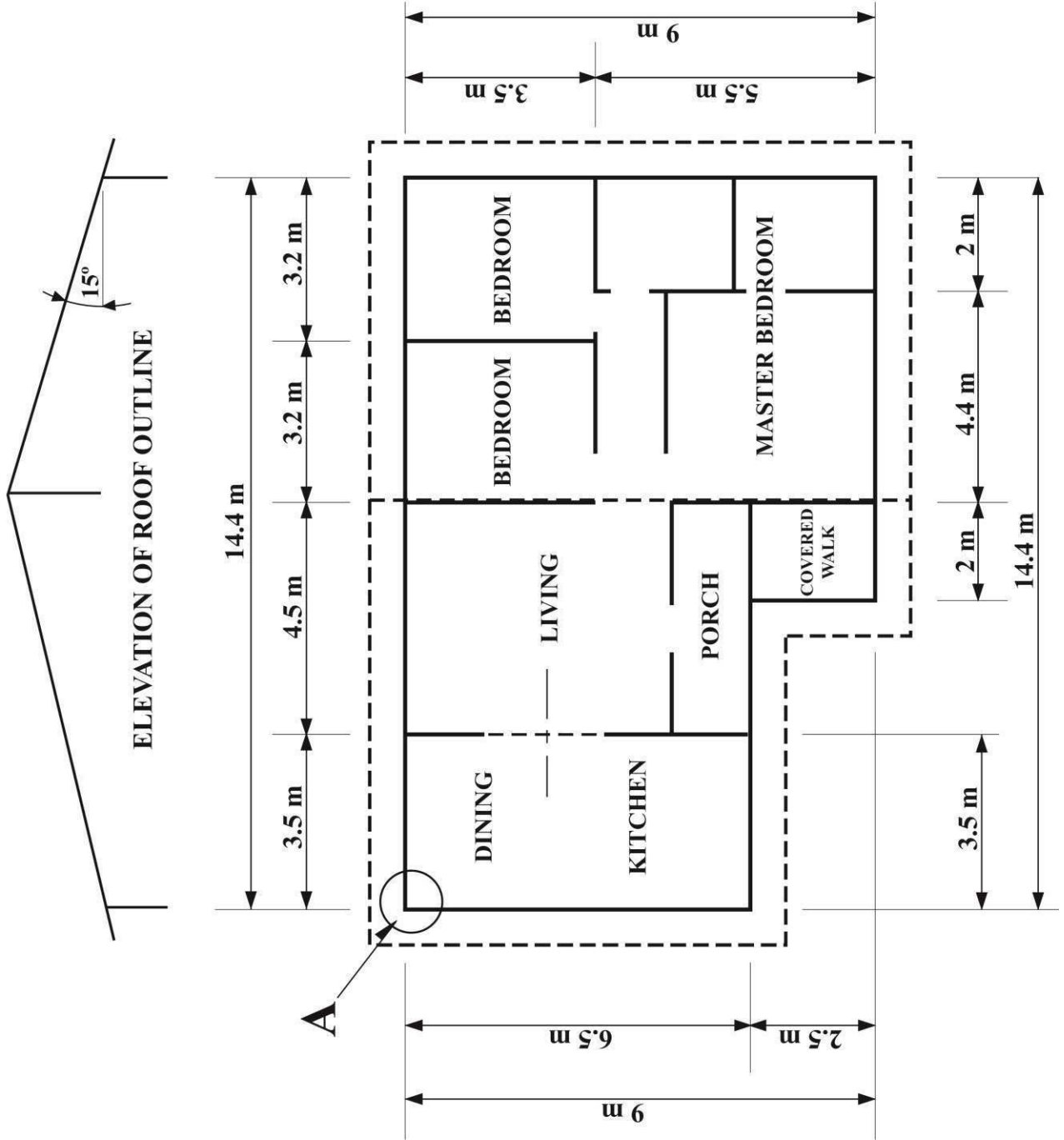

Figure 1

GO ON TO THE NEXT PAGE

(a) Sketch and label the foundation detail as at 'A' showing clearly:

- (i) 600 mm strip footing with reinforced concrete
- (ii) 200 mm floor slab
- (iii) Hardcore
- (iv) Sand screed
- (v) PVC damp proofing

**[Total 30 marks]**

**END OF TEST**



C A R I B B E A N            E X A M I N A T I O N S            C O U N C I L

CARIBBEAN SECONDARY EDUCATION CERTIFICATE®  
EXAMINATION

TECHNICAL DRAWING

BUILDING DRAWING

PAPER 02 - GENERAL PROFICIENCY

SOLUTIONS AND MARK SCHEME

SPECIMEN PAPER 2015

**Note: Scoring methods used are the global/holistic method and analytical method.**

TECHNICAL DRAWING  
 BUILDING DRAWING  
 PAPER 02  
 SOLUTIONS AND MARK SCHEME

QUESTION	KNOWLEDGE	MARKS	APPLICATION	MARKS	PRACTICAL ABILITY	MARKS
1.	Knowledge of: <ul style="list-style-type: none"> <li>- Roof framing plan:                             <ul style="list-style-type: none"> <li>• Plan outline</li> <li>• Roof members (ridge, rafters, laths, wall plate)</li> <li>• Eaves</li> </ul> </li> <li>- Dimensions</li> <li>- Labelling</li> <li>- Scale</li> </ul>	9       2     3     4	Principles of: <ul style="list-style-type: none"> <li>- Roof plan</li> <li>- Drawing roof plan to a scale of 1:50</li> <li>- Representation of framing plan                             <ul style="list-style-type: none"> <li>• Plan outline</li> <li>• Roof framing members (ridge, rafters, laths, wall plate)</li> </ul> </li> <li>- Dimensioning</li> <li>- Labelling</li> </ul>	8       8       10       6       4	Accuracy of: <ul style="list-style-type: none"> <li>- Roof plan</li> <li>- Dimensions</li> <li>- Dimensioning technique</li> <li>- Completed roof plan to include:                             <ul style="list-style-type: none"> <li>• Plan outline</li> <li>• Roof framing members (ridge, rafters, laths, wall plate)</li> <li>• Eaves</li> </ul> </li> </ul> Printing: <ul style="list-style-type: none"> <li>- Labelling</li> <li>- Title</li> <li>- Scale</li> <li>- Neatness/CAD presentation</li> <li>- Line work/line type</li> </ul>	8       6       4       9       3       1       1       2       2
		<b>18</b>		<b>36</b>		<b>36</b>

TECHNICAL DRAWING  
BUILDING DRAWING  
PAPER 02  
SOLUTIONS AND MARK SCHEME

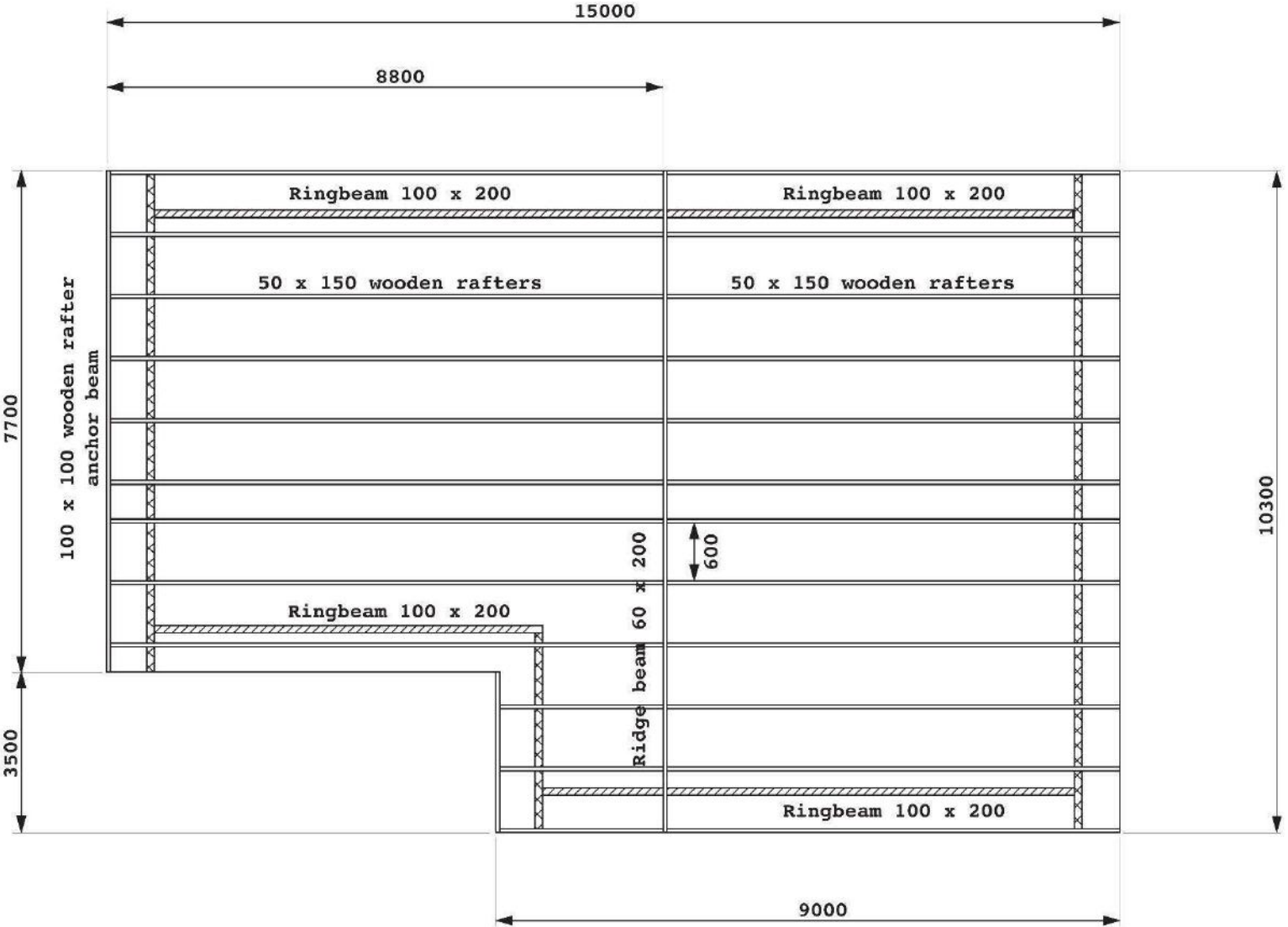

NOTE  
Close board roof: Sheet board  
screwed to rafter  
Open roof: Laths screwed to  
rafter every 600 c/c

ROOF FRAMING PLAN

ROOF FRAMING PLAN  
SCALE: 1:50



TECHNICAL DRAWING  
BUILDING DRAWING  
PAPER 02  
SOLUTIONS AND MARK SCHEME

QUESTION	KNOWLEDGE	MARKS	APPLICATION	MARKS	PRACTICAL ABILITY	MARKS
2	Knowledge of: <ul style="list-style-type: none"> <li>- Foundation</li> <li>- Foundation footing details               <ul style="list-style-type: none"> <li>• Reinforced concrete footing</li> <li>• Floor slab</li> <li>• Sand screed</li> <li>• Hardcore</li> <li>• PVC damp proofing</li> </ul> </li> </ul>	2  4	Principles of: <ul style="list-style-type: none"> <li>- Foundation</li> <li>- Representation of foundation footing details               <ul style="list-style-type: none"> <li>• Reinforced concrete footing</li> <li>• Floor slab</li> <li>• Sand screed</li> <li>• Hardcore</li> <li>• PVC damp proofing</li> </ul> </li> <li>- Proportion</li> </ul>	3  6   2	Accuracy of: <ul style="list-style-type: none"> <li>- Foundation detail</li> <li>- Representation of footing details</li> <li>- Proportion</li> <li>- Neatness/CAD presentation</li> </ul>	3  6  2  2
		<b>6</b>		<b>11</b>		<b>13</b>

TECHNICAL DRAWING  
BUILDING DRAWING  
PAPER 02  
SOLUTIONS AND MARK SCHEME

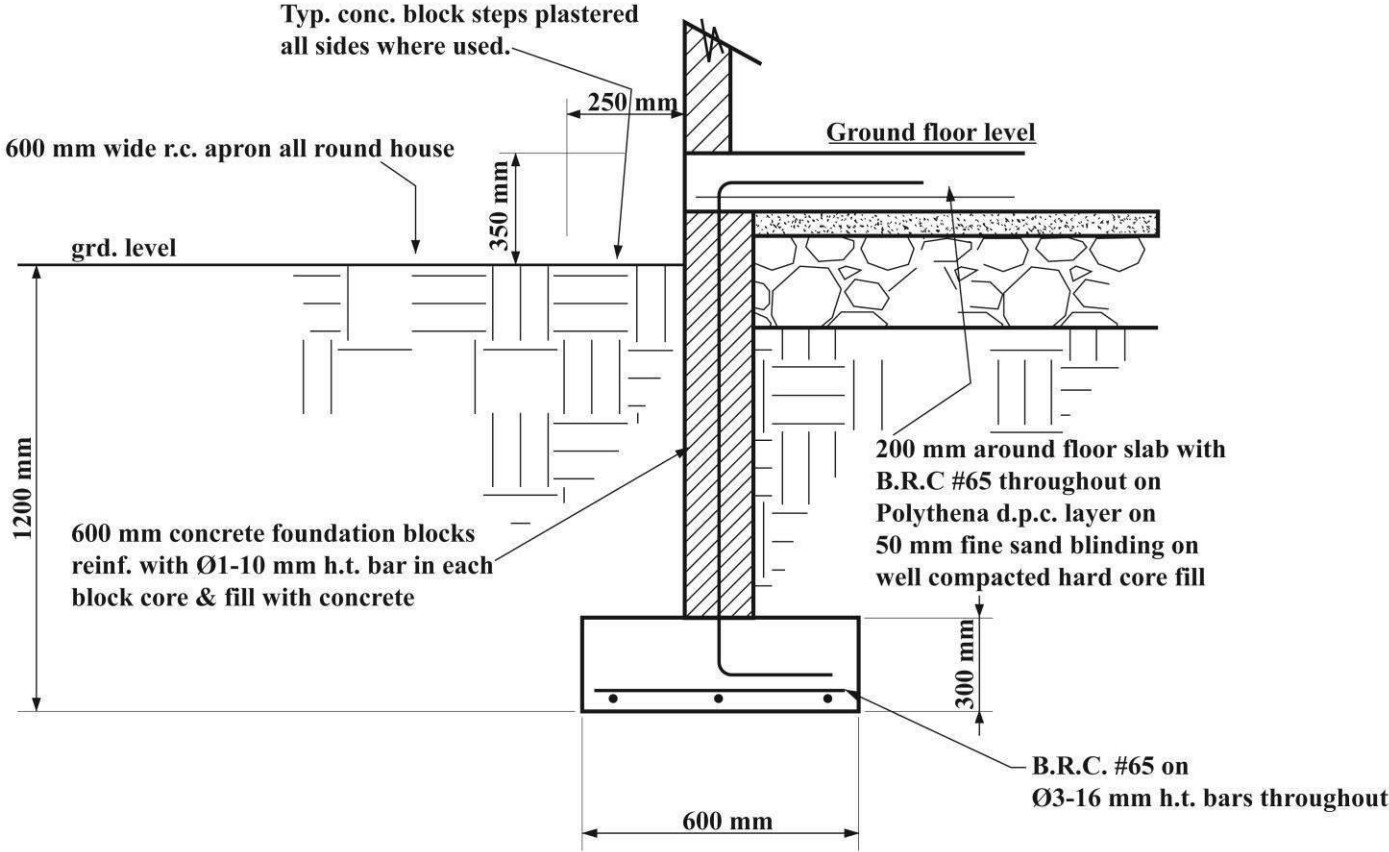

FOUNDATION DETAIL AT 'A'

SOLUTION TO QUESTION 2

**CARIBBEAN EXAMINATIONS COUNCIL**

**REPORT ON CANDIDATES' WORK IN THE  
SECONDARY EDUCATION CERTIFICATE EXAMINATION**

**MAY/JUNE 2009**

**TECHNICAL DRAWING**

**TECHNICAL DRAWING  
GENERAL PROFICIENCY EXAMINATION  
MAY/JUNE 2009**

**GENERAL COMMENTS**

In the 2009 examination, the number of entries for the General Proficiency was 8 793.

The revised syllabus and SBA format are now an established exercise. Although performance on the SBA (Paper 04) continues to be fairly good, there remains room for improvement. Some teachers are still indicating that they have not seen the syllabus amendments.

Teachers are asked to note the amendment to the syllabus (Appendix 1 – CXC 13/0/SYLL 005) which came into effect in 2006. This details the format for the School-Based Assessment (SBA) project and teachers are advised to follow the recommended mark scheme as grading of their students may be seriously disadvantaged if they fail to do so.

Teachers are reminded to adhere to standard drawing practices, especially for working drawings, for **all** papers. Significant declines in drawing standards have been observed on all papers. Generally, the use of scales as well as lettering, labelling and dimensioning are areas which need to be emphasized. When the completing working drawings, all drawings must be labelled and dimensioned. In the case of sectional drawings, hatching lines to show various materials and cutting plane lines must be shown.

All topics outlined in the syllabus must be covered in order to adequately prepare candidates for the examination.

Candidates preparing for the examination in Technical Drawing are encouraged to acquire a background in at least one of the allied subjects of Industrial Arts. For example, a candidate choosing the Building Drawing option should be encouraged to also choose one of the Building Technology options. Likewise a candidate choosing the Mechanical Drawing option should choose Mechanical Engineering at the CSEC level.

**DETAILED COMMENTS**

**General Proficiency**

**Paper 01 – Multiple Choice**

This paper consisted of sixty multiple choice items testing the profile dimensions of Knowledge (Profile 1), Application (Profile 2) and Practical Ability (Profile 3). The mean performance of candidates on the paper showed some improvement when compared to 2008.

**Paper 02 – Plane and Solid Geometry**

**Plane Geometry**

**Question 1**

This question was designed to test candidates' ability to:

- (a) Construct a triangle ABC with an altitude of 70 mm and base angles CAB and ABC equal to  $45^\circ$  and  $60^\circ$  respectively.
- (b) Inscribe the LARGEST square within the triangle, with one side lying on AB.

Generally, candidates who attempted this question demonstrated a good grasp of how to construct the triangle.

However, some candidates demonstrated lack of knowledge in constructing the triangle with the given base angles and altitude and also in inscribing the largest square within the triangle.

### Question 2

Candidates were presented with a figure of a triangle with a wheel.

This question was designed to test candidates' ability to:

- (a) Construct a right-angled triangle with a wheel diameter.
- (b) Construct a cycloid for the circle rolling along AC of the triangle.

Generally, most candidates who attempted this question, demonstrated a grasp of constructing the triangle.

However, some candidates demonstrated lack of knowledge in constructing the cycloid from the initial starting point.

### Question 3

Candidates were presented with the outline for a template.

This question was designed to test candidates' ability to:

- (a) Reproduce the figure, showing clearly, the construction methods used for obtaining the straight line AB and the centre of the arcs required.
- (b) Identify clearly the method of obtaining all points of tangency.

Generally, candidates who attempted this question demonstrated a good grasp in reproducing the given two circles and arc.

However, most candidates demonstrated a lack of knowledge of the construction for obtaining the centres for the required two arcs and the straight line AB.

### Question 4

Candidates were presents with a rhombus ABCD with its diagonals AC and BD and a rod EF with a point P on it.

This question was designed to test candidates' ability to:

- (a) Construct the rhombus with the given diagonal, sides, the rod EF and point P.
- (b) Plot the locus of point P, as EF of constant length slides between the diagonals so that its ends E and F are always on the diagonals.

Generally, candidates who attempted this question demonstrated a very good grasp of constructing the rhombus to include the rod EF with points P.

However, most candidates demonstrated a lack of knowledge for sliding the rod EF between the diagonals and obtaining the locus of P.

#### Question 5

Candidates were presented with a figure showing the elevation and plan of a channel block, with the location of the picture plane, ground line, centre line of vision, sight-point, vanishing point and horizontal line for the preparation of a one-point perspective view of the channel block.

This question was designed to test candidates' ability to:

- (a) Copy the given layout as shown.
- (b) Construct a one-point perspective view of the channel block.

Generally, candidates who attempted this question demonstrated a good grasp in reproducing the given layout.

However, most candidates demonstrated lack of knowledge of constructing the one-point perspective view of the channel block.

#### Question 6

Candidates were presented with a figure showing the elevation and incomplete plan of a truncated hexagonal pyramid.

This question was designed to test candidates' ability to draw the:

- (a) Given elevation and completed plan showing the cut surface
- (b) Development of the truncated pyramid with seam as indicated

This question was popular and few candidates who attempted it demonstrated a good grasp in drawing the given elevation and completed plan.

#### Question 7

Candidates were presented with a figure showing the plan and elevation of a line AB.

This question was designed to test candidates' ability to:

- (a) Draw the given plan and elevation.
- (b) Determine the true length of AB, by revolution or auxiliary method.
- (c) Measure and state the true length of AB.

Generally, candidates who attempted this question demonstrated a good grasp of drawing the line AB in plan and elevation.

However, some candidates were unable to determine the true length of the line AB by either method required.

### Question 8

This question was designed to test candidates' ability to draw ONE complete turn of a right-hand helical circular cross-section spring, with a pitch of 120 mm, centre line diameter 116 mm and cross-section diameter 16 mm.

Generally, candidates who attempted this question demonstrated a good grasp of drawing the pitch and circular diameter with their division to obtain the helix.

However, most candidates were unable to complete the right-hand helical circular cross-section spring.

## **Paper 03/1 – Building Drawing**

### Question 1

Candidates were presented with the outline of a floor plan for a one-bedroom cottage at a hotel resort. The building was to be of concrete block construction and covered with a hip roof.

In Part (a) candidates were required to draw to a scale of 1:50, the completed floor plan of the building. The working drawing was to include the following:

- Internal and external walls
- All windows and doors
- Kitchen appliances, cupboards and cabinets
- Bathroom fixtures
- Names of all rooms
- Closets
- 6 main external dimensions
- 2 overall dimensions

In Part (b), candidates were required to draw to a scale of 1:200, the completed site plan for the building. The front of the building was to be placed parallel to the road and the completed drawing was to include:

- Proposed building
- Road/driveway
- Septic tank, soak away and sewer lines
- Distances from boundary lines
- Dimensions of property lines
- North arrow
- Trees and shrubs

A suitable title and scale used were to be printed at the base of each drawing. Specifications for all construction members were provided.

Many candidates who attempted this question demonstrated a high level of knowledge, understanding and ability in drawing of the floor plan at a scale of 1:50. However, candidates seemed not to understand fully the use of scales, for example, instead of indicating the actual measurement of the object, they indicated the scaled measurement as measured on the drawing paper.

The inclusion of drawing features such as internal and external walls, doors and windows as well as kitchen appliances were aspects well done. Labelling of rooms and dimensioning techniques were also done satisfactorily.

Although the floor plan was generally well done, some candidates seemed to be still experiencing difficulty with drawing the bathroom fixtures to scale. In most cases, these were drawn undersized and incorrectly placed, thereby making them impractical.

Other aspects of weakness were the quality of labelling, dimensioning techniques and the omission of the printed title and scale used as required by the question.

In producing the drawings for this question, most candidates did not adhere to the principles of good working drawing practice. Consequently, they were unable to score the maximum marks allotted for the question.

Teachers are reminded that this is the “**Working Drawing**” section of the examination. As such, standard drawing practices and conventions for completing working drawings are to be followed.

### Question 2

In this question, candidates were presented with the outline of a floor plan for a one-bedroom cottage at a hotel resort. The building was to be covered with



Labelling and sizing of stair members were aspects which were done satisfactorily.

#### Question 4

This question tested the candidates' ability to make neat, well-proportioned sketches to illustrate details of the layout for a simple framed wooden partition indicating a door and window opening. All components were to be clearly labelled.

Candidates who attempted this question demonstrated a good grasp of the concept of pictorial sketching in proportion. However, the majority of candidates were only able to produce the drawing of the casement window.

Many candidates were unable to draw and label window members. In most cases, window types other than the one requested in the question were produced.

Attention must be given in the classroom to **all** aspects of the syllabus. Sketching of wooden partition components (Unit 3, Module 6, Specific Objectives 2 and 3) appears to be an area of weakness.

### **Paper 03/2 – Mechanical Engineering Drawing**

#### **Assembly Drawing**

##### Question 1

Candidates were presented with an enclosed sheet showing first-angle, orthographic projection details of the parts which make up a rotary tool head assembly.

In Part (a), candidates were required to draw, full size, in first-angle or third-angle orthographic projection the following views of the rotary tool head assembly when fully assembled.

- (i) A plan showing all hidden details.
- (ii) A full sectional front elevation taken on the cutting plane line B – B.

In Part (b), candidates were required to show six main dimensions, including a length, a diameter, a radius and a metric screw thread specification.

In Part (c), candidates were required to print the title, "Rotary Tool Head Assembly", the scale used, and show the projection method used by symbol.

Most candidates who attempted this question demonstrated good knowledge of assembling the parts and correctly positioning the views in the projection method used. This knowledge enabled the correct assembly of the given parts and the positioning and alignment of the required views in relation to the projection method used. Most candidates were also able to demonstrate understanding of the use of the correct cutting plane and to locate the cutting plane on the finished drawing. The required plan was generally well completed with most hidden details included. Candidates were also able to indicate the required engineering features such as fillet and chamfer on the assembly drawing.

Some aspects of the question that were not well done included incomplete sectional elevations. In this regard, some candidates demonstrated weakness in correctly using hatching to distinguish the different components and the web in the assembly. In some cases the web was hatched. The conventional representation of engineering features such as the knurl and screw thread was poorly done by some

candidates and teachers need to pay attention to how their students are made aware of the importance of such engineering features.

The dimensioning techniques caused concern. Attention needs to be paid by candidates to the selection of required dimensions and correctly completing the dimensioning techniques. Aspect of dimensioning that require additional practice include the correct shape and size of arrow heads, extension line details and indicating dimensions requiring metric symbols. Attention must be given to the use of appropriate dimensioning standards that adhere to CXC syllabus requirements, for example BSI PD 7308. Candidates still need to improve their line work. Reference is therefore made to syllabus UNIT 3, MODULE 3.

### Question 2

Candidates were presented with an enclosed sheet showing first-angle, orthographic projection details of the parts which make up a swivel jig assembly.

In Part (a), candidates were required to draw, full size, in first-angle or third-angle orthographic projection the following views of the swivel jig when fully assembled.

- (i) A plan showing all hidden details.
- (ii) A full sectional, front elevation taken on the cutting plane line A – A as it passes through the 12 mm diameter hole in the swivel link.

In Part (b), candidates were required to show six main dimensions, including a length, a diameter, a radius and a metric screw thread specification.

In Part (c), candidates were required to print the title, “Swivel Jig Assembly”, the scale used, and show the projection method used, by symbol.

Most candidates who attempted this question demonstrated some knowledge and understanding of orthographic projection and correctly positioned and aligned the views in relation to the projection method used. Engineering features such as the knurl, chamfer and fillet were widely known.

However, many candidates demonstrated weakness with regard to the correct assembly of parts. The major issue was placing the parts in the correct positions. Hatching to distinguish the different components of the assembly was poorly done; with many candidates sectioning the web. As a result the sectional elevation was not always fully completed.

Dimensioning was another aspect of the drawing that was not well done. Attention must be given to the use of appropriate dimensioning standards that adhere to CXC syllabus requirements, for example BSI PD 7308.

Candidates need to improve their line work, including the use of construction lines, hidden lines and centre lines. Reference is therefore made to syllabus UNIT 3, MODULE 3.

### **Sketch and Design or 3D Solid Model Design Drawing**

#### Question 3

This question tested the candidates’ ability to use neat, well-proportioned, orthographic sketches for the conventional representation of the following engineering features:

- (a) Fillet weld
- (b) Grooved weld

- (c) Hollow shaft/tubular section
- (d) Cylindrical spring
- (e) Spot face (two views required)

Generally, this question was not well done. Most candidates who attempted it were able to sketch the hollow shaft/tubular section, the fillet weld and to some extent the groove weld. However, most of the conventional representations required were either poorly sketched or not attempted at all. Candidates also had difficulty sketching proportionately in orthographic projection. The poor responses to this item suggest that this aspect of the syllabus is either not taught or insufficient practice is provided. Reference is therefore made to syllabus UNITS 3, MODULES 5, 6 and 7.

#### Question 4

Candidates were presented with a sectional elevation and an end elevation of a support bracket in first-angle orthographic projection. They were required to sketch in isometric projection, the support bracket.

Generally, candidates who attempted this question satisfactorily converted the orthographic views to a proportional isometric figure. However, many candidates were unable to orient the isometric sketch to show the sectional details as required. Candidates should be exposed to more practice in drawing isometric views, particularly with respect to orienting drawings according to given instructions.

### **School Based Assessment**

There has been a general improvement in the performance of the candidates in the SBA in 2009. Of the 164 centres moderated, grades for 112 were accepted while 52 had to be adjusted. Although the performance this year was good, there are still some candidates whose performance is not up to the required standard for CXC.

The moderating team, however, realizes that there are a number of problems which have to be solved in order for candidates to produce improved performances in the future.

These problems include:

- (a) The drawing of objects to scale
- (b) Omission of problem statements, conditions and justifications
- (c) Reproduction of drawings without any modification
- (d) Incorrect dimensioning of objects (dimensioning orthographic views)

#### Projects

Some projects were too simple and were therefore not suitable to be used as an SBA assignment. Candidates can redesign existing engineering devices; however, the drawings must show how these improvements are to be achieved.

Also some devices which were designed were non-functional. Teachers should make sure that their students understand that the project which they design should be functional.

### Dimensioning

All dimensions should be metric and should reflect that the candidates know how to correctly draw to scale. Drawings coming to the marking team indicate that candidates have been dimensioning projects using measurements which they used to draw the object on the paper. In most cases, these dimensions do not reflect the actual size of the object. Drawings should be drawn to a scale.

### Auto Cad drawings

When drawings have been produced using CAD, candidates should show that they understand how to differentiate between construction lines, outline, hidden lines and the like. Therefore, the weighting of the lines should be reflected. If candidates are not fully competent in the use of the CAD program, then they should not be allowed to complete the assignment using the computer.

There is a misconception among candidates that a drawing produced using the computer will be awarded high marks. These drawings must meet proper drawing standards. Marks awarded by the teacher should be shown on the candidates profile sheet. These sheets should be attached to the candidate's work. Teachers are once again reminded to use the mark scheme which is provided by CXC. Failure to do so will place their students at a disadvantage.

**C A R I B B E A N      E X A M I N A T I O N S      C O U N C I L**

**REPORT ON CANDIDATES' WORK IN THE  
SECONDARY EDUCATION CERTIFICATE EXAMINATION**

**MAY/JUNE 2010**

**TECHNICAL DRAWING  
GENERAL PROFICIENCY**

**Copyright © 2010 Caribbean Examinations Council  
St Michael, Barbados  
All rights reserved.**

## GENERAL COMMENTS

In the 2010 examination, the number of entries for the General Proficiency increased to 9315.

The revised syllabus and School-Based Assessment (SBA) format is now an established feature of the examination. Although performance on the SBA continues to be fairly good, there still remains room for improvement. Some teachers are still indicating that they have not seen syllabus amendments.

Teachers are asked to note the amendment to the syllabus (Appendix 1 – CXC 13/0/SYLL 005) which came into effect in 2006. This details the format for the SBA project and teachers are encouraged, as far as possible, to follow the recommended mark scheme.

Candidates are reminded to adhere to standard drawing practices, especially for Working Drawings and Assembly Drawings, for **all** papers. Significant declines in drawing standards have been observed on all papers. Generally, the use of scales as well as lettering, labelling and dimensioning are areas which need to be emphasized. When completing Working Drawings, all drawings must be fully labelled and dimensioned. In the case of Sectional Assembly Drawings, hatching lines to show various materials and cutting plane lines must be shown.

All topics outlined in the syllabus must be covered in order to adequately prepare students for the examination.

Candidates preparing for the examination in Technical Drawing are encouraged to acquire a background in at least one of the allied subjects of Industrial Arts. For example, a student choosing the Building Drawing option should be encouraged to also choose one of the Building Technology options. Likewise, a student choosing the Mechanical Drawing option should choose Mechanical Engineering at the CSEC level.

## DETAILED COMMENTS

### Paper 01 – Multiple Choice

This paper consisted of 60 multiple choice questions testing the profile dimensions of Knowledge (Profile 1), Application (Profile 2) and Practical Ability (Profile 3). Performance on this year's multiple choice paper declined over that of 2009. This year the average was 36, with a standard deviation of 9.66.

### Paper 02 – Plane and Solid Geometry

#### Plane Geometry

##### Question 1

This question was designed to test candidates' ability to:

- (a) Draw a line AB 150 mm long.
- (b) Divide the line AB, geometrically, into seven equal parts.
- (c) Draw a circle using five parts of the line AB as the diameter.
- (d) Construct the largest regular pentagon that could be fitted within the circle.

Generally, candidates who attempted this question demonstrated a good knowledge of drawing the line AB to the correct length and dividing it geometrically.

However, most candidates demonstrated lack of knowledge of drawing the largest regular pentagon to fit within the circle. Some candidates could not accurately use the five parts to draw the required circle. Many candidates demonstrated limited knowledge in using the stated method to construct a pentagon or even to identify a pentagon.

### Question 2

This question was designed to test candidates' ability to construct:

- (a) A parallelogram ABCD, given the length of two adjacent sides and the angle between them
- (b) A square equal in area to the parallelogram

Generally, candidates who attempted this question demonstrated good knowledge of constructing the parallelogram and were able to reproduce the given figure. However, some candidates could not go beyond that to construct the square equal in area to the parallelogram.

### Question 3

Candidates were presented with the base, one side and an angle of a triangle. This question was designed to test candidates' ability to construct:

- (a) The triangle ABC given the lengths of two adjacent sides and the angle between them.
- (b) A triangle XYZ similar to triangle ABC and with a perimeter of 240 mm.

Generally, candidates who attempted this question demonstrated good knowledge of constructing the given triangle, ABC. However, many candidates were unable to demonstrate knowledge of constructing the similar triangle XYZ given the perimeter of 240 mm. In some cases, a similar triangle was drawn as a separate figure.

### Question 4

Candidates were presented with a figure representing a simple link mechanism with given dimension.

Candidates were required to:

- (a) Copy the given mechanism.
- (b) Plot the locus of point 'P' as OA makes one complete revolution.

Generally, candidates who attempted this question demonstrated a good grasp of copying the mechanism and plotting the locus of 'P' accurately showing the rotation of OA. However, some candidates experienced difficulty and were unable to demonstrate their knowledge of moving point 'B' along XY in order to plot the path of point 'P'.

## **Solid Geometry**

### Question 5

Candidates were presented with a figure showing the Front Elevation and Plan of an I-shaped bar. They were expected to draw:

- (a) The given Front Elevation and Plan
- (b) An Auxiliary Elevation of the bar on the XY line.

Generally, candidates who attempted this question demonstrated a good grasp of drawing the given Front Elevation and Plan. However, some candidates were only able to demonstrate limited knowledge of drawing the Auxiliary Elevation of the bar on the given XY line. Candidates were unable to demonstrate understanding in projecting lines perpendicular to the auxiliary axis.

#### Question 6

Candidates were presented with a figure showing two orthographic views of a truncated right rectangular prism. This question was designed to test candidates' ability to draw full size:

- (a) The two given views.
- (b) The development of the truncated right rectangular prism with  $C_1 C_1$  as the seam.

Generally, candidates who attempted this question demonstrated good knowledge of drawing the given views, from the given dimensions, in orthographic projection.

However, some candidates demonstrated a lack of knowledge and understanding in completing the development of the truncated rectangular prism. Many candidates were unable to identify the correct position of the seam on the figure.

#### Question 7

Candidates were presented with two incomplete orthographic views of a cylinder intersecting a hexagonal prism at  $60^\circ$ . This question was designed to test candidates' ability to:

- (a) Draw the given views.
- (b) Complete the elevation showing the curve of interpenetration between the hexagonal prism and the cylinder.
- (c) Complete the plan showing the curve for the end of the cylinder.

Generally, candidates who attempted this question demonstrated good knowledge and understanding in drawing the given views. However, some candidates demonstrated limited knowledge and so were not able to complete:

- (i) The elevation with the curve of interpenetration between the hexagonal prism and the cylinder.
- (ii) The plan showing the curve for the end of the cylinder.

#### Question 8

In this question, candidates were presented with orthographic views of a Wooden Block. The question was designed to test candidates' ability to:

- (a) Draw an isometric view of the Block with 'S' as its lowest point.

Generally, candidates who attempted this question demonstrated good knowledge of the isometric principles for drawing the Block with 'S' as its lowest point.



## Paper 03/1 – Building Drawing

### Question 1

Candidates were presented with the outline of a floor plan for a two-bedroom low income residential project. The building was to be of concrete block construction and covered with a gable roof.

In Part (a) candidates were required to draw to a scale of 1:50, the full sectional drawing of the building. The Working Drawing was to include the following:

- Foundation
- Floor
- Walls
- Roof
- At least three vertical dimensions

In Part (b), candidates were required to draw to a suitable scale, an enlarged sectional view of a typical floor detail. All sectional floor and foundation details were to be shown.

A suitable title and the scale used were to be printed at the base of **each** drawing. Specifications for all construction members were provided.

Many candidates who attempted this question demonstrated a high level of knowledge, understanding and ability in drawing a full sectional drawing of a building to a scale of 1:50. The section details, especially floor and foundation sections, were well done.

Although the enlarged sectional floor detail was generally well done, many candidates experienced some difficulty in completing the drawing. The Damp Proof Membrane (DPM) was an important aspect of floor construction which was omitted by many candidates. Principles of section drawing, for example, hatching, were not adhered to and some candidates experienced much difficulty in representing roof members in section.

Other aspects of weakness were the quality of labelling, vertical dimensioning techniques and the omission of the printed title and scale used as required by the question.

In producing the drawings for this question, most candidates did not adhere to the principles of good Working Drawing practice. Consequently, they were unable to score the maximum marks allotted for the question.

Teachers are asked to remind candidates that this is the ‘**Working Drawing**’ section of the examination. As such, standard drawing practices and conventions for completing Working Drawings are to be followed.

### Question 2

Candidates were presented with the outline of a floor plan for a two-bedroom low income residential project. The building was to be of concrete block construction and covered with a gable roof.

In Part (a), candidates were required to draw to a scale of 1:50, the completed floor plan for the building to show:

#### Wall thicknesses

- Kitchen appliances and base cupboards
- All doors and windows
- Bathroom fixtures
- Names of all rooms
- 10 external dimensions
- 2 overall dimensions

In Part (b), candidates were required to draw two views of the building to a scale of 1:50, namely:

- (i) The front elevation
- (ii) The side elevation

A suitable title and the scale used were to be printed at the base of **each** drawing. Specifications were provided for all construction members. Standard drawing practices and conventions for drawing floor plans and elevations were to be followed.

Many candidates who attempted this question demonstrated a high level of knowledge, understanding and ability in drawing the floor plan at a scale of 1:50. However, candidates seemed not to fully understand the use of scales. For example, although they drew the plan at the correct scale, in many cases, bathroom fixtures were drawn too small and were therefore not practical.

The inclusion of drawing features such as internal and external walls, doors and windows as well as kitchen appliances were aspects well done. Labelling of rooms and dimensioning techniques were also done satisfactorily.

Although the floor plan was generally well done, some candidates seemed to experience difficulty in interpreting the required elevations for the building. In most cases, they experienced difficulty in interpreting the roof design and the porch in elevation.

Other aspects of weakness were the quality of labelling, dimensioning techniques and the omission of the printed title and scale used as required by the question.

In producing the drawings for this question, most candidates did not adhere to the principles of good Working Drawing practice. Consequently, they were unable to score the maximum marks allotted for the question.

#### Question 3

Candidates were required to make a neat, well-proportioned sketch to show a detailed sectional view of a sliding window in a masonry wall. Sketches were to include hatching to show material representation. All main components were to be clearly shown and labelled.

The majority of candidates who attempted this question did a good job of executing the sketch in good proportion. Although most candidates were able to identify some kind of window, some candidates could not identify the sectional view of a sliding window. Some drawings were produced in elevation.

Labelling and sizing of members were aspects which were done satisfactorily. Attention must be given by candidates to **all** aspects of the syllabus. Drawing of a detailed section of a sliding window (horizontal and vertical sliding) appears to be an area of weakness.

#### Question 4

This question tested candidates' ability to make a neat well-proportioned three-dimensional sketch to illustrate an exterior view of the given building when viewed with 'X' as the lowest point. All external features were to be clearly shown.

Candidates who attempted this question demonstrated a good grasp of the concept of pictorial sketching in proportion. However, the majority of candidates were unable to correctly interpret the roof design and include the porch in the drawing.

In some cases, candidates produced a roof plan instead of the full pictorial drawing.

### **Paper 03/2 – Mechanical Engineering Drawing**

#### **Assembly Drawing**

#### Question 1

Candidates were presented with an enclosed sheet showing first-angle, orthographic projection details of the parts which make up a Shaft Steady Assembly.

In Part (a), candidates were required to draw, full size, in first-angle or third-angle orthographic projection, the following views of the Shaft Steady when fully assembled:

- (i) A full sectional front elevation taken on the cutting plane line A–A
- (ii) The end view looking in the direction of arrow 'B'

Candidates were also required to show hidden details only on the end view and the cutting plane line on the end view.

In Part (b), candidates were required to show six main dimensions, including a length, a diameter, a radius and a metric screw thread specification.

In Part (c), candidates were required to print the title, 'Shaft Steady Assembly', the scale used, and show the projection method used by symbol.

Most candidates who attempted this question demonstrated good knowledge, application and practical ability in correctly assembling the parts and the majority correctly positioned and aligned the views in relation to the orthographic projection method used. Correctly applying dimensions to the drawing was another aspect of the question that was well done. Candidates demonstrated that they were aware of and could apply the principles involved in dimensioning orthographic drawings.

Aspects of the question that were not well done included section details and cross-hatching to distinguish components that have been cut from those that have not been cut. For example, candidates did not know how to treat the 'Hinge Pin' and 'Pivot Pin' to distinguish them from other components. Additionally, candidates were challenged in showing the internal details for the slotted ends of the 'Shaft Body' and 'Shaft Cap'. Some candidates sectioned these areas as though they were cut. Some candidates also had difficulty showing distinctions between the webs and other parts of the assembled steady. Other aspects of the drawing that presented challenges included showing centre lines for shafts, such as holes, showing cutting plane lines and some dimensioning according to specifications.

Candidates need to complete more Sectional Assembly Drawings to show internal details of parts; the application of varying line types, particularly hatching lines, centre-lines and cutting plane lines; and handling features such as webs. Although printing the projection method, scale and title of the drawing have improved, some candidates still need to work on these aspects. Overall, candidates still need to pay attention to linework and dimensioning.

### Question 2

Candidates were presented with an enclosed sheet showing first-angle, orthographic projection details of the parts which make up an 'Angled Winding Jig Assembly'.

In Part (a), candidates were required to draw, full size, in first-angle or third-angle orthographic projection, the following views of the angled winding jig when fully assembled:

- (i) A full sectional, front elevation taken on the cutting plane line B–B.
- (ii) The plan with hidden details shown.

In Part (b), candidates were required to show six main dimensions, including a length, a diameter, a radius and a metric screw thread specification.

In Part (c), candidates were required to print the title, 'Angled Winding jig Assembly', the scale used, and show the projection method used, by symbol.

Most candidates who attempted this question demonstrated good knowledge, application and practical ability in correctly assembling the components and they correctly positioned and aligned the views in relation to the projection method used. Dimensioning the finished drawing was another aspect of the question that was generally well done. Most candidates demonstrated sound knowledge and application of conventional symbols such as fillet and chamfer. The requirement for candidates to demonstrate knowledge and application of screw threads and hidden details was generally met.

In this question, some candidates experienced difficulty with positioning the split bushing on the 12 mm diameter end of the winding shaft and showing the details in the sectional front elevation. Another aspect of the question that candidates had challenges with was the use of appropriate hatching lines to distinguish different parts of the assembly. Candidates are reminded that sectioning conventions in mechanical engineering use hatching lines in different directions to indicate different parts of the assembly, and where several parts are in close proximity and are all cut, then the closeness of the hatching lines are varied to distinguish these parts. Other aspects of the drawing that presented challenges included showing centre lines for shafts, such as holes, showing cutting plane lines, and in some instances, completing dimensioning according to specifications.

### **Sketch and Design OR 3D Solid Model Design Drawing**

### Question 3

This question tested candidates' ability to use a neat, well-proportioned, isometric sketch to show the views of the given 'support bracket' assembled with 'B' as its lowest point.

Generally, candidates who attempted this question demonstrated good knowledge and application of the principles of orthographic projection to correctly interpret the given views and sketch the required figure with 'B' in the lowest position. However, a number of candidates had difficulty using the principles of drawing circles and curves in isometric to complete the required isometric sketch. As a result of this limitation, candidates' final sketch had curves and circles that were poorly drawn.

Sketching objects to proportion needs to be given attention as some candidates experienced difficulties with this aspect.

#### Question 4

This question tested candidates' ability to make neat, well-proportioned sketches to illustrate three of the following engineering features:

- (a) A castle nut
- (b) A slotted nut
- (c) A stud
- (d) A set screw

Generally, candidates who attempted this question experienced difficulty sketching the required engineering fasteners. Candidates experienced difficulty distinguishing between the slotted nut and castle nut. Additionally, knowledge of set screws and studs appeared to be very limited. This limited knowledge of engineering fasteners meant that candidates found it difficult illustrating them. Because all aspects of the syllabus are important, attention must be given to the entire syllabus, so that candidates are appropriately prepared to answer questions related to any part of the syllabus.

#### **Paper 04 – School-Based Assessment (SBA)**

There has been a general improvement in the performance of candidates in the 2010 SBA. Although the performance this year was good, there are still some candidates whose performance is not up to the required standard. The following points therefore need to be re-emphasized:

1. The drawing of objects to scale.
2. Omission of problem statements, conditions and justifications.
3. Reproduction of drawings without any modification.
4. Incorrect dimensioning of objects (dimensioning orthographic views).
5. Inconsistency with roof pitches from roof framing plan to elevations.
6. Dimensioning: problems range from the absence of dimensions to incorrect dimensioning techniques.

#### **NOTES TO TEACHERS**

Teachers must adhere to the parameters of the syllabus, for example, in the case of Building Drawing, candidates should concentrate on the planning of single-story buildings only.

Marks are allocated for pictorial drawing in the mark scheme. Teachers should therefore teach some form of pictorial drawings (Isometric, Oblique or Perspective). This will enable candidates to produce a three-dimensional drawing as part of the School-Based Assessment.

Problem statements, conditions and justification for the particular design must be submitted with the drawings. It is not possible to fully understand a design concept and make a judgment on the drawings produced by candidates if the design justification is not given. Candidates are required to solve a particular problem, not just reproduce a drawing. There must be some evidence of research done in order to solve the problem.

Teachers are therefore required to formulate problems in the various areas which will test candidates' ability to solve a problem. When marking assignments, teachers are reminded that they should also include the mark scheme detailing how the marks have been allocated for each student.

**CARIBBEAN EXAMINATIONS COUNCIL**

**REPORT ON CANDIDATES' WORK IN THE  
SECONDARY EDUCATION CERTIFICATE EXAMINATION**

**MAY/JUNE 2011**

**TECHNICAL DRAWING  
GENERAL PROFICIENCY EXAMINATION**

**Copyright © 2011 Caribbean Examinations Council  
St Michael, Barbados  
All rights reserved.**

## GENERAL COMMENTS

In 2011, there was a slight increase in the number of candidates writing the examination, from 7,559 in 2010 to 7,569 in 2011.

Overall, there was a slight decline in candidates' performance. Although performance on the School-Based Assessment (SBA) (Paper 04) continues to be fairly good, there still remains room for improvement. Teachers are reminded to note the amendment to the syllabus (Appendix 1 – CXC 13/0/SYLL 005) which came into effect in 2006. This details the format for the SBA project and teachers are encouraged to follow the recommended mark scheme as grading of their students may be seriously disadvantaged.

Teachers are also reminded to adhere to standard drawing practices, especially for working drawings and assembly drawings, for all papers. A significant decline in drawing standards has been observed across all papers. Generally, the use of scales as well as lettering, labelling and dimensioning are areas which need to be emphasized and improved. When completing Working Drawings, all drawings must be fully labelled, annotated and dimensioned. In the case of Sectional Assembly Drawings, hatching lines to show various materials and cutting plane lines must be shown.

There appears to be some selection in the topics covered by teachers in preparing students for the examination. All topics outlined in the syllabus must be covered in order to ensure adequate preparation of students as this may seriously affect question selection. Also, teachers are encouraged to place emphasis on the reading and interpretation of question requirements. For example, in the Building Drawing (Paper 031 – Question 1) paper, candidates were presented with a Floor Plan and asked to produce the Roof Framing Plan for the given design. Many candidates reproduced the Floor Plan without taking note of the question requirements.

Again, recommendations are made for candidates preparing for the examination in Technical Drawing to acquire a background in at least one of the allied subjects of Industrial Arts. For example, a candidate choosing the Building Drawing option should be encouraged to also choose one of the Building Technology options. Likewise, a candidate choosing the Mechanical Drawing option should choose Mechanical Engineering at the CSEC level. This would no doubt strengthen the underpinning knowledge requirements of the subject area.

## DETAILED COMMENTS

### Paper 01 – Multiple Choice

This paper consisted of 60 multiple-choice questions testing the profile dimensions of Knowledge (Profile 1), Application (Profile 2) and Practical Ability (Profile 3). Candidates' performance in the 2011 paper showed a slight decline when compared with June 2010. The overall mean was 33.39 compared with 35.91 for June 2010. Marks ranged from 3 to 59 out of a maximum of 60.

### Paper 02 – Plane and Solid Geometry

#### Plane Geometry

##### Question 1

Candidates were presented with the length of one side of a regular pentagon. This question was designed to test candidates' ability to:

- (a) Construct the regular pentagon.

- (b) Enlarge the regular pentagon to a similar figure with linear measurements of its sides in the ratio 3:5.

Generally, candidates who attempted this question demonstrated good knowledge of constructing the pentagon. However, some candidates were unable to enlarge the pentagon with measurements of sides in the ratio 3:5. In some cases, area ratio was drawn.

Teachers are asked to refer to Unit 1, Module III, Specific Objective 8 of the syllabus.

### Question 2

Candidates were presented with information necessary for constructing a triangle. This question was designed to test candidates' ability to:

- (a) Construct the triangle using the given information — lengths of sides.
- (b) Draw three circles to touch each other using the vertices of the triangle as their respective centres.

Generally, candidates who attempted this question demonstrated good knowledge of constructing the triangle. However some candidates were unable to demonstrate knowledge of constructing the three circles to touch each other.

Teachers should refer to Unit 1, Module III, Specific Objective 1 and Module IV, Specific Objective 3 of the syllabus.

### Question 3

Candidates were presented with a figure representing a simple link mechanism. This question was designed to test candidates' ability to:

- (a) Copy the given mechanism.
- (b) Plot the locus of point B as OA makes one complete revolution.

Generally, candidates demonstrated a good grasp of copying the mechanism and plotting the locus of B accurately, showing the rotation of AO, while AB slides through the pivot block C. However, some candidates experienced difficulty demonstrating knowledge of sliding AB through the pivot block C in order to plot the path of point B.

Teachers should refer to Unit 1, Module VI, Specific Objective 4.

### Question 4

Candidates were presented with the longest radius (120mm) and shortest radius (20mm) for constructing one convolution of an Archimedean spiral. This question was designed to test candidates' ability to construct the spiral given the radii.

Generally, candidates demonstrated good knowledge of constructing the Archimedean spiral with the longest and shortest radii. However, some candidates demonstrated no knowledge of a spiral. In some cases, involutes and cycloids were presented.

Teachers should refer to Unit 1, Module VI, Specific Objective 6 of the syllabus.



## **Solid Geometry**

### Question 5

Candidates were presented with the first angle orthographic views of a Bracket and a reference line XY inclined at  $45^\circ$  to the horizontal. This question was designed to test candidates' ability to draw:

- (a) The given front elevation and plan.
- (b) An auxiliary elevation of the Bracket on the XY line.

Generally, candidates demonstrated a good grasp of drawing the given views. However, some candidates demonstrated limited knowledge of drawing an auxiliary elevation of the Bracket on the given line 'XY'. Candidates were also unable to demonstrate an understanding of projected lines, perpendicular to the auxiliary axis.

Teachers should refer to Unit 1, Module VIII, Specific Objective 1 as well as Module IX, Specific Objective 1 of the syllabus.

### Question 6

Candidates were presented with a figure showing two orthographic views of a truncated regular hexagonal pyramid. This question was designed to test candidates' ability to draw full size:

- (a) The two given views.
- (b) The completed plan.
- (c) The surface development of the pyramid with S-S as the seam.

Generally, candidates demonstrated an ability to draw the given views. However, some candidates were unable to complete the plan and determine the true length for the corners of the pyramid in order to draw the correct surface development.

Teachers should refer to Unit 1, Module VIII, Specific Objective 1 and Module X, Specific Objective 2 of the syllabus.

### Question 7

Candidates were presented with the plan and incomplete elevation of a vertical cylinder penetrated by a horizontal cylinder. This question was designed to test candidates' ability to:

- (a) Draw the given views.
- (b) Complete the elevation showing the curve of interpenetration between the two cylinders and the face of the horizontal cylinder.

Generally, candidates who attempted this question demonstrated good knowledge and understanding of drawing the given views. However, some candidates also demonstrated limited knowledge completing the elevation showing the curves of intersection between the cylinders and the curves of the face of the horizontal cylinder.

Teachers should refer to Unit 1, Module VIII, Specific Objective 1 and Module IX, Specific Objective 5 of the syllabus.

### Question 8

In this question, candidates were presented with orthographic views of a Machine Block. The question was designed to test candidates' ability to draw a cabinet oblique view of the block.

Generally, candidates who attempted this question demonstrated good knowledge of drawing a machine block in cabinet oblique. However, some candidates used the cavalier method of oblique drawing and/or the isometric.

Teachers should refer to Unit 1, Module VII, Specific Objective 1 of the syllabus.

## **Paper 031 – Building Drawing**

### Question 1

Candidates were presented with the outline of a floor plan for a two-bedroom, low-income residential project. The building was to be of concrete block construction and covered with a gable roof.

In Part (a), candidates were required to draw to a scale of 1:50, the Roof Framing Plan for building. The Working Drawing was to include the following:

- Foundation
- Floor
- Walls
- Roof
- At least three vertical dimensions

In Part (b), candidates were required to draw to a scale of 1:50, the Foundation Plan of the building. All sectional floor, foundation and footing details were to be shown.

A suitable title and scale used was to be printed at the base of each drawing. Specifications for all construction members were provided.

Many candidates demonstrated a high level of knowledge, understanding and ability in drawing the roof framing plan to a scale of 1:50, showing the given roof outline of a gable roof with a valley.

Although the foundation plan was generally well done, many candidates experienced some difficulty in identifying the footing and foundation wall. Dimensioning of the foundation plan was an area of weakness demonstrated by most candidates.

Other aspects of weakness were the quality of labelling of roof members, dimensioning techniques and the omission of the printed title and scale used as required by the question.

Many candidates responded to this question by reproducing the given floor plan instead of using the information given to produce the roof framing plan and foundation plan.

In producing the drawings for this question, most candidates did not adhere to the principles of good working drawing practice. Consequently, they were unable to score the maximum marks allotted for the question.

Teachers are reminded that this is the *Working Drawing* section of the examination. As such, standard drawing practices and conventions for completing working drawings are to be followed.

### Question 2

Candidates were presented with the outline of a floor plan for a two-bedroom residence. The design of the roof was indicated on the drawing. The building was to be of concrete block construction.

In Part (a), candidates were required to draw to a scale of 1:50, the completed floor plan for the building to show:

- Internal and external walls
- Kitchen appliances, cupboards and cabinets
- All doors and windows
- Bathroom fixtures
- Closets
- Names of rooms
- Eight main external dimensions

In Part (b), candidates were required to draw the Front Elevation of the building to a scale of 1:50, to show clearly the design of the roof. The outline of the roof was shown in hidden detail on the given drawing.

A suitable title and scale used was to be printed at the base of each drawing. Specifications were provided for all construction members. Standard drawing practices and conventions for drawing floor plans and elevations were to be followed.

Many candidates demonstrated a high level of knowledge, understanding and ability in the drawing of the floor plan at a scale of 1:50. However, candidates seemed not to understand fully the use of scales, for example, although they drew the plan at the correct scale, in many cases, bathroom fixtures were drawn too small and were therefore not practical.

The inclusion of drawing features such as internal and external walls, doors and windows as well as kitchen appliances were aspects well done. Labelling of rooms and dimensioning techniques were also done satisfactorily.

Although the floor plan was generally well done, some candidates still seemed to be experiencing difficulty in interpreting the required elevation for the building. In most cases, they experienced difficulty in interpreting the roof design in elevation.

Other aspects of weakness included the quality of labelling, dimensioning techniques and the omission of the printed title and scale used as required by the question.

In producing the drawings for this question, most candidates did not adhere to the principles of good working drawing practice. Consequently, they were unable to score the maximum marks allotted for the question.

### Question 3

Candidates were required to make a neat, well-proportioned, orthographic sketch of a timber straight flight stair. Sketches were to include the following main parts of the stair in elevation:

- (a) Newel post
- (b) Balluster
- (c) Handrail
- (d) String
- (e) Tread

All main components were to be clearly shown and labelled.

The majority of candidates who attempted this question did a good job of executing the sketch in good proportion. Although most candidates were able to draw parts of a straight flight stair, some candidates could not label the parts correctly. Some candidates produced a concrete stair.

Attention must be given in the classroom to all aspects of the syllabus. Drawing of a wooden straight flight stair (Unit 2, Module IX, Specific Objectives 2 and 4) appears to be an area of weakness.

### Question 4

This question tested candidates' ability to make a neat, well-proportioned three-dimensional sketch to illustrate:

- (a) Aluminum guttering on closed eave
- (b) Concrete coping on block wall
- (c) Plywood sub-flooring on timber framed floor

All components were to be labelled.

Candidates who attempted this question demonstrated a good grasp of the concept of sketching in proportion. However, the majority of candidates were unable to sketch in pictorial correctly. Many candidates produced orthographic sketches.

Interpreting the various construction details was an area of extreme weakness. Teachers are reminded to ensure complete syllabus coverage in order to allow students to take maximum advantage of marks to be awarded.

In this case, the areas following are aspects of the syllabus which need to be emphasized.

Unit 2:

- Module I, Specific Objective 4
- Module V, Specific Objective 1
- Module VI, Specific Objective 1
- Module VII, Specific Objective 4

### **Paper 032 – Mechanical Engineering Drawing**

#### **Assembly Drawing**

##### Question 1

Candidates were presented with an enclosed sheet showing first-angle, orthographic projection details of the parts, which make up a tool rest holder.

In Part (a), candidates were required to draw, full size, in first-angle or third-angle orthographic projection the following views of the tool rest holder when fully assembled:

- (i) A plan
- (ii) An end elevation looking from arrow A with all hidden detail shown
- (iii) A full sectional front elevation taken on the cutting plane line, C – C

In Part (b), candidates were required to show six main dimensions, including a length, a diameter, a radius and a metric screw thread specification.

In Part (c), candidates were required to print the title, *Tool Rest Holder Assembly*, the scale used, and show the projection method used, by symbol.

Most candidates who attempted this question demonstrated reasonably good knowledge, application and practical ability in correctly positioning and aligning the views drawn in relation to the orthographic projection method used. In cases where candidates used Computer Aided Drawing (CAD), this was well done, though there were instances of candidates not completing the drawing process. Candidates demonstrated sound knowledge of, and the ability to apply engineering features such as fillets, screw threads and chamfers. In cases where candidates completed the assembly and sectional front elevation, the cross-hatching used to distinguish parts such as the locking screw, bolt and washer and the screw plate was well done.

Aspects of the question that were not well done included assembly of parts. Several candidates assembled the components incorrectly, for example some candidates assembled the screw plate where the locking screw was to be attached to the body. Other candidates placed the locking plate on the top portion of the body in various ways. It was clear, therefore, that some candidates had very little knowledge of mechanical engineering components and how they are constructed.

Another aspect that was not well done related to incorrectly hatching cut surfaces to distinguish between different components. Additionally, several candidates had difficulty indicating the correct

projection symbol according to the projection method they used. Attention must be paid to completing sectional drawings showing the cutting line.

Attention is drawn to Unit 3, Module VI, which identifies types of mechanisms with which candidates should become familiar.

### Question 2

Candidates were presented with an enclosed sheet showing first-angle, orthographic projection details of the parts, which make up an adjustable pulley assembly.

In Part (a), candidates were required to draw, full size, in first-angle or third-angle orthographic projection the following views of the fully assembled adjustable pulley.

- (i) A front elevation looking in the direction of arrow F with all hidden details shown
- (ii) A full sectional, end elevation taken on the cutting plane line B–B

In Part (b), candidates were required to show six main dimensions, including a length, a diameter, a radius and a metric screw thread specification.

In Part (c), candidates were required to print the title, *Adjustable Pulley Assembly*, the scale used, and show the projection method used, by symbol.

Most candidates who attempted this question demonstrated reasonably good knowledge, application and practical ability in correctly positioning and aligning the views in relation to the orthographic projection method used. Assembly of the given components was also fairly well done, with most candidates positioning the components correctly. Candidates also showed good knowledge of, and application of the engineering features required: fillet, screw thread and chamfer.

Most candidates' application of and practical ability in cross-hatching to show details of the assembled Tool Rest Holder such as distinguishing parts, shafts and webs were well done. Candidates demonstrated good knowledge of dimensioning and that they could accurately apply the principles involved in dimensioning orthographic drawings. Linework was generally well done, with at least most linetypes required being evident.

Some candidates showed weakness in relation to assembling the pulley at the lowest possible position according to instructions. Other areas where some candidates showed weaknesses included poor sectioning and hatching line use to distinguish details of the assembly such as webs and shafts. Some candidates hatched the slot through which the shaft passed. Several candidates did not include the cutting plane line as required by convention. Additionally, several candidates had difficulty indicating the correct projection symbol according to the projection method they used. Candidates need to improve their linework and some dimensioning techniques.

Attention is drawn to Unit 3, Module VI, which identifies types of mechanisms with which candidates should become familiar. Additionally, attention is drawn to Unit 3, Module II.3 and Module IV.1.

### **Sketch and Design OR 3D Solid Model Design Drawing**

### Question 3

This question tested candidates' ability to use a neat, well-proportioned, isometric sketch to show the elevations of the given support bracket assembled with 'Y' as its lowest point.

Generally, candidates who attempted this question demonstrated good knowledge of elevations in orthographic projection and applied that knowledge to produce an appropriate isometric sketch with 'Y' as the lowest point. Some candidates ably produced the required circles and arcs in isometric and were able to accurately apply the inclined lines. Sketching to proportion was also generally well done.

Areas of weakness included candidates not demonstrating good practical ability in sketching isometric curves and circles. Some candidates had challenges completing these accurately even though knowledge of drawing isometric curves and circles was evident.

Attention is drawn to Unit 3, Module VII.2, which identifies types of engineering components which candidates should be able to sketch in 3D.

#### Question 4

This question tested candidates' ability to make neat, well-proportioned orthographic sketches to illustrate four of the following locking devices in application:

- (a) Lock nut
- (b) Self-locking nut
- (c) Tab washer
- (d) Spring washer
- (e) Slotted nut
- (f) Castle nut

Generally, performance on this question was poor. Candidates demonstrated limited knowledge of locking devices generally, but more specifically in application as required for the question. However, some candidates were able to produce well-proportioned sketches of the spring washer, slotted nut and castle nut, although in most instances the pin was not included in the sketch of the slotted nut and castle nut.

Attention is drawn to Unit 3, Module VII.1, which speaks to the need for candidates to be able to sketch the features of engineering components using standard graphic symbols.

### **Paper 032 – School-Based Assessment (SBA)**

There has been a marked improvement in the performance of candidates in the 2011 SBA. Of the 233 centres moderated, grades for 163 were accepted while 70 had to be adjusted. Although the performance this year was good, there are still some centres where submissions made by students are not up to the required standard for the CSEC examination.

This improvement indicates that teachers have acknowledged suggestions made in previous subject reports and have been instructing students accordingly. However, although teachers have been complying with the recommendations, there are still some points, which need to be re-emphasized.

These include:

1. The drawing of objects/figures to scale
2. Omission of problem statements, conditions and justifications

3. Reproduction of drawings without any modifications
4. Incorrect dimensioning of objects (Dimensioning of orthographic views and floor plans, using measurements on the paper instead of actual dimensions — demonstrating a lack of understanding of scale)
5. Omission of dimensions (Some drawings were submitted without a single dimension)

### **Mark Scheme**

Building drawing students as a general rule do not produce pictorial drawings. They are required to produce floor plans, sectional view, roof details, foundation plans and elevations. This therefore creates a problem when the CXC mark scheme is applied. A number of teachers have expressed concerns over the fact that the current mark scheme for the SBA does not allow for the adequate marking of Building Drawing. While the concerns of teachers are appreciated, it is recommended that all building students should submit a pictorial drawing to ensure maximum advantage on the mark scheme.

### **Appropriateness of Task**

Any work given to students should be geared towards testing some aspect of the CSEC syllabus. Consideration should be given to the designing, researching and manufacturing (production) of the item or service. (**Note:** The task given should not be beyond the expected skill level of students at the CSEC level.)

In the case of building drawing, students should produce floor plans, sectional views, roof details foundation plans, pictorials and elevations. Mechanical drawing students should be expected to produce pictorial drawings, sectional elevations, orthographic projections and exploded views. Parts in the solution should also be clearly identified.

### **Submission of Problem Statements and Mark Schemes**

Teachers are expected to ensure that each student's folder contains information on the problem being presented (problem statement, conditions and justifications). Teachers are also expected to submit the CXC mark scheme clearly showing how marks were awarded to each student. This can be achieved by submitting a copy of the mark scheme showing the allocation of marks in the categories of knowledge, application and practical ability.



**C A R I B B E A N    E X A M I N A T I O N S    C O U N C I L**

**REPORT ON CANDIDATES' WORK IN THE  
CARIBBEAN SECONDARY EDUCATION CERTIFICATE® EXAMINATION**

**MAY/JUNE 2013**

**TECHNICAL DRAWING  
GENERAL PROFICIENCY EXAMINATION**

**Copyright © 2013 Caribbean Examinations Council  
St Michael, Barbados  
All rights reserved.**

## GENERAL COMMENTS

In the 2013 examination, the number of entries decreased slightly to 9 162. The number of candidates earning Grades I–III in 2013 was 74.4 per cent compared with 65 per cent in 2012. Additionally, the number of candidates earning Grade I also increased from eight per cent in 2012 to 17 per cent in 2013. This improved performance was reflected in improved performance on all three profiles. In Profile 1, knowledge improved from 72 per cent in 2012 to 82 per cent in 2013; for Profile 2, application improved from 63 per cent in 2012 to 73 per cent in 2013; and for Profile 3, practical ability improved from 54 per cent in 2012 to 66 per cent in 2013.

The revised syllabus and School-Based Assessment (SBA) format is now an established exercise. Although performance on the SBA (Paper 04) continues to be fairly good, there still remains room for improvement. Teachers are reminded to note the amendment to the syllabus (Appendix 1 – CXC 13/0/SYLL 005) which came into effect in 2006 and still remains in effect. This details the format for SBA project and teachers are encouraged to follow the recommended mark scheme as grading of their students could be seriously disadvantaged.

Again, teachers are reminded to adhere to standard drawing practices, especially for working drawings and assembly drawings, for **all** papers. Some decline in drawing standards has been observed on all papers. Teachers must ensure that students read the question paper thoroughly before attempting questions and ensure that they respond to question requirements.

In general, the use of scales as well as lettering, labelling and dimensioning are areas which need to be emphasized. When completing working drawings, drawing titles must be printed at the base of each drawing. In the case of sectional assembly drawings, hatching lines to show various materials and cutting plane lines **must** be shown. Titles, projection symbols and the scale used must be printed at the base of each drawing. All drawings **must** be fully labelled, annotated and dimensioned. In attempting questions on the Plane and Solid Geometry paper, all construction lines must be shown. This applies to the use of both computer aided drawing or traditional methods.

All topics outlined in the syllabus must be covered in order to ensure adequate preparation of students as this may seriously affect question selection. Also, teachers are encouraged to place emphasis on the reading and interpretation of question requirements. For example, in the Building Drawing (Paper 031 – Question 2) paper, candidates were presented with the outline of a floor plan and roof design. Candidates were asked to produce a full sectional drawing of the building. Many candidates simply reproduced the floor plan without attempting to produce the required sectional view. This situation severely affected candidates' ability to gain maximum marks on the question.

Again, recommendations are made for candidates preparing for the examination in Technical Drawing to acquire a background in at least one of the allied subjects of Industrial Arts. For example, a student choosing the Building Drawing option should be encouraged to also choose one of the Building Technology options. Likewise a student choosing the Mechanical Drawing option should choose Mechanical Engineering at the CSEC level. This would no doubt strengthen the underpinning knowledge requirements of the subject area.

## DETAILED COMMENTS

### Paper 01 – Multiple Choice

This paper consisted of 60 multiple-choice questions, testing the profile dimensions of Knowledge (Profile 1), Application (Profile 2) and Practical Ability (Profile 3). The mean score of 35.7 showed some improvement in candidates' performance on the paper compared with 33.6 for 2012.

### Paper 02 – Plane and Solid Geometry

This paper tested candidates' use of knowledge, application of knowledge and practical ability in solving plane and solid geometry problems. It was divided into two sections each containing four questions, of which candidates were required to choose two from each section. Each question was worth 20 marks. The mean score of 36.1 showed improvement in candidates' performance compared with 31.8 for 2012.

#### Section I – Plane Geometry

##### Question 1

In this question, candidates were presented with a rhombus, ABCD, with side  $AB = 50$  mm and diagonal  $BD = 85$  mm.

The question was designed to test candidates' ability to construct the following:

- (a) The given rhombus
- (b) A similar figure having twice the area of ABCD

Generally, few candidates who attempted this question demonstrated some knowledge of a rhombus and therefore were able to construct the figure from the given data (Part (a)) and, they were also able to construct a similar figure (Part (b)) having twice the area.

However, the majority of candidates who attempted this question demonstrated a lack of knowledge of a rhombus and the principles of similar figures with differences between area and linear ratios. The poor performance on this question is reflected in a mean mark of only 5.4. Additionally, 28 per cent of candidates who attempted this question scored zero.

##### Question 2

Candidates were presented with the outline of a disc of 60 mm diameter that rolls along a flat surface A-B without slipping, so that the point 'P' on the circumference of the disc generates a cycloid.

Candidates were required to:

- (a) draw the given figure
- (b) plot the cycloid traced by the point 'P', as the disc rolls along A-B for one complete revolution without slipping.

Generally, candidates who attempted this question demonstrated knowledge of and practical ability in copying the disc on the flat surface A-B, and were able to accurately plot the cycloid traced by point 'P'. Some candidates, however, experienced difficulty and were unable to demonstrate the application of their knowledge to plotting the cycloid starting from the given point 'P'. The mean mark for this question was 10.2, with three per cent of candidates achieving full marks.

### Question 3

This question was designed to test candidates' knowledge and application of knowledge about triangles.

Candidates were required to

- (a) construct a triangle, ABC, with AB as base = 70 mm, angle CAB  $45^{\circ}$  and angle ABC =  $60^{\circ}$ .
- (b) construct an escribed circle to the triangle.

Generally, candidates demonstrated a good grasp of how to construct the triangle from the given data. However, some candidates demonstrated lack of knowledge of the escribed circle by either drawing an inscribed or circumscribed circle. The mean mark for this question was 12.4, with 11 per cent of candidates gaining full marks.

### Question 4

In this question, candidates were presented with a diagram showing a circle of diameter 80 mm and a line, BC.

The ratio of the diameter of the circle to the line was 7:5. Candidates were required to

- (a) construct the given circle and the line BC
- (b) construct a tangent and a normal to the circle from point C.

Generally, candidates who attempted this question demonstrated a good grasp of reproducing the given circle and the line BC. However, most candidates demonstrated a lack of knowledge of the construction for obtaining the tangent and the normal. The mean mark for this question was 9.4, with six per cent of candidates scoring full marks.

## **Section II – Solid Geometry**

### Question 5

Candidates were presented with the plan and an incomplete elevation of a hexagonal prism intersected by a cylinder with their axes on the same plane. This question was designed to test candidates' ability to:

- (a) construct the given plan
- (b) construct the completed elevation to show the curve of interpenetration of the cylinder.

Generally, candidates who attempted the question demonstrated good knowledge and application of knowledge in drawing the given views. However, some candidates demonstrated limited knowledge of interpenetration and therefore were unable to complete the elevation, showing the curve of interpenetration. The mean mark for the question was 10.4, with eight per cent of candidates scoring full marks.

### Question 6

Candidates were presented with a figure showing the plan and elevation of two lines, ab and bc. Candidates were required to

- (a) draw the plan and elevation of the lines as given
- (b) project an end view on the right of the given elevation
- (c) determine the true length of the lines ab and bc by the revolution or auxiliary method.

Generally, candidates who attempted this question demonstrated a good grasp of drawing the plan and elevation of the lines as given. However, many candidates demonstrated limited knowledge of projecting the end view and obtaining the true length of the two lines by either of the methods required. This question was not very popular. The mean mark was 7.5, with three per cent of candidates gaining full marks. This topic appears to present challenges to some teachers and students. The topic needs to be taken seriously, as it has been tested quite often over the years.

### Question 7

Candidates were presented with a figure showing two orthographic views of a truncated cylinder. This question was designed to test candidates' ability to

- (a) draw the view as given
- (b) construct the development of the truncated cylinder with the seam as indicated.

Generally, candidates who attempted this question demonstrated good knowledge of drawing the given views. However, some candidates demonstrated a lack of knowledge and understanding of constructing the development of the truncated cylinder with the seam in the given position. This was the most popular question in the section. The mean mark was 9.8, with five per cent of candidates gaining full marks.

### Question 8

In this question, candidates were presented with a figure showing two orthographic views of a block. Candidates were not required to copy these views.

This question was designed to test candidates' ability to interpret the given orthographic views to produce an isometric drawing of the block with 'S' as its lowest point.

Generally, candidates who attempted the question demonstrated good knowledge of isometric principles for drawing the block with 'S' as its lowest point. However, construction of isometric circles was a challenge for some candidates. This question was popular among candidates. The mean mark was 10.5, with six per cent of candidates gaining full marks.

### **Recommendations for Teachers**

In respect to Paper 02, teachers should focus on the specific objectives of the syllabus to ensure that their students are well prepared for the geometry in Technical Drawing.

## **Paper 031 – Building Drawing**

This paper consisted of two sections: Section I – Working Drawing and Section II – Sketch and Design or 3D Solid Model Design Drawing. Section I had two optional questions each worth 80 marks and Section II had two optional questions each worth 20 marks. Candidates were required to answer one question from each section. The percentage of candidates earning Grades I–III on Paper 031 for 2013 was 58 per cent compared with 38 per cent for 2012. The mean score on this paper was 52.6 compared with 42.1 in 2012. This represents an improvement in performance on this paper compared with performance in 2012.

### **Section I – Working Drawing**

#### Question 1

Candidates were presented with the outline of a floor plan for a two-bedroom holiday cottage. The building was to be of concrete block construction and covered with a gable roof.

In Part (a), candidates were required to draw, to a scale of 1:50, the completed floor plan of the building. The working drawing was to include the following:

- i. Internal and external wall thickness
- ii. All doors and windows
- iii. Kitchen appliances, cupboards, base cabinets and work triangle
- iv. Bathroom and laundry fixtures
- v. Ten main external dimensions
- vi. Overall dimensions

In Part (b), candidates were required to draw to a scale of 1:10, a typical roof anchorage detail for the gable roof of the cottage. The detailed drawing was to include the following labelled elements:

- i. Ring beam
- ii. Wall plate
- iii. Rafters
- iv. Laths
- v. Hurricane straps

A suitable title and scale were to be printed at the base of each drawing. Specifications for all construction members were provided. Candidates were allowed to use their discretion for dimensions not given.

This question was attempted by the majority of candidates who opted for the Building Drawing component of the examination. The examiners were of the view that most candidates may have opted for this question due to the heavy focus on this area during preparation for the examination. Many of the candidates who attempted this question demonstrated the appropriate knowledge about floor plans and successfully applied this knowledge to the production of the required drawing. This proficiency was shown in the drawing of the floor plan to the required 1:50 scale, drawing internal and external walls, labelling rooms correctly, appropriate dimensioning techniques, and drawing of windows and doors. Weaker candidates did not follow specifications for wall thickness, doors and windows and had difficulty representing the internal and external walls in the drawing which were usually all the same thickness or not to scale.

While aspects of the floor plan were satisfactorily drawn, some candidates seemed to have difficulty with the following:

- Drawing bathroom and kitchen fixtures to scale — In most cases these were drawn undersized and incorrectly placed, thereby making them impractical.
- Drawing the patio and porch — In some cases an external wall was drawn around the space instead of the edge of floor to outside.
- Representation of the work triangle — In some cases, fixture layout was poor or no lines representing the work triangle were provided.

In Part (b), candidates seemed unsure of the building details for roof anchorage. A large number of candidates chose to draw a plan view (or pictorial view) instead of a 1:10 detail section. In instances when a section was drawn, it exhibited one or a combination of the following:

- Elements limited to just the wall and roof
- Incorrect assembly of members/elements
- Improper size of members
- Incorrect labelling (wrong identification, wrong leader lines)

Other aspects of weakness in Question 1 overall were

- The quality of drawings (line work and line type not properly done)
- Labelling (text being unreadable, not straight, varied sizes)
- Dimensioning techniques (dimensions did not connect to lines properly, orientation, accuracy, inconsistency in arrows/ticks)
- The omission of the printed title and scale used, as required by the question.

In producing the drawings for this question, most candidates did not adhere to the principles of good working drawing practice. Consequently, they were unable to score maximum marks.

Teachers are reminded that this is the working drawing section of the examination. As such, standard practices and conventions for completing working drawings are to be rigorously followed.

This question was the more popular of the two optional questions in this section. The mean mark was 41.4. No candidate earned full marks for this question; however, ten per cent of the candidates earned marks ranging from 60 to 78.

## Question 2

In this question, candidates were required to use the same outline of a floor plan used in Question 1. In Part (a), candidates were required to draw, to a scale of 1:50, a cross-section of the building as indicated on the outline as "A-A". The section drawing was to include the following:

- Foundation
- Floor
- Walls
- Roof
- Vertical dimensions
- Ten labels with sizes

Candidates were asked to show all construction details that would be seen in the section.

In Part (b), candidates were asked to draw, to a scale of 1:50, an elevation of the building as indicated on the outline by the arrow "B". The elevation drawing was to include the following:

- All door and window positions
- Roof outline and fascia board
- Three vertical dimensions

A suitable title and scale were to be printed at the base of each drawing. Specifications for all construction members were provided. Candidates were allowed to use their discretion for dimensions not given. Standard drawing practices and conventions for drawing sections and elevations were to be followed.

Candidates who attempted this question showed the appropriate proficiency in drawing a building section to scale given only a floor plan. Candidates also demonstrated the required knowledge of foundation and floor systems. Notwithstanding the high quality of responses, the following general weaknesses were observed

- Candidates were unsure of the building details for roof assembly — In some cases, they were not of the members needed, improper labelling, incorrect member sizes and details were limited to simply wall and roof.
- Representations of doors and windows — In some cases, doors and windows were placed at incorrect heights, incorrectly drawn sizes and types (as opposed to specs).
- Vertical dimensioning was weak — In some cases, text, orientation, accuracy, and technique were improper.

Performance on Part (b) directly reflected performance on Part (a). Candidates exhibited a high level of proficiency in generating an elevation to scale. Weaker candidates, however, experienced difficulty interpreting the required elevation for the building. Problems were seen in the placement of doors and windows, locating the patio and drawing the ground plane. There was general difficulty interpreting the roof of the elevation.

Weaknesses seen in Question 1 were also observed in Question 2. These included the quality of drawings, labelling, dimensioning techniques and the omission of the printed title and scale used as required by the question. In producing the drawings for this question, most candidates did not adhere to the principles of good working drawing practice. Consequently, they were unable to score the maximum marks allocated to the question.

This question was the least popular of the two optional questions in this section. The mean mark was 50.5 which is significantly higher than the mean mark for the more popular Question 1. No candidate earned full marks; however, 30 per cent of candidates earned marks ranging from 60 to 78.

## **Sketch and Design or 3D Solid Model Design Drawing**

### Question 3

This question tested candidates' knowledge of doors as well as their ability to sketch in three dimensions. Candidates were required to make neat well-proportioned 3D/pictorial sketches to show a three panel solid wood door and a flush door, and state the respective names below the sketches.



This question was very popular and candidates demonstrated very good knowledge of the difference between the two door types. There was a general weakness, however, in sketching the doors pictorially. Some candidates chose instead to draw orthographic elevations of the doors. While candidates distinguished between the doors, the panels were not drawn accurately and the core and outer skin of the flush door were omitted. Sketching pictorially appears to be an area of weakness. The mean mark for this question was 12.7, with 11 per cent of candidates earning full marks.

#### Question 4

This question tested candidates' knowledge of wall systems. Candidates were required to make neat well-proportioned sketches in orthographic section to show the difference between a load bearing and non-load bearing wall, and to state the respective names below the sketches.

This was by far the least popular question of the two optional questions in this section. Stronger candidates responded to the question successfully; however, these were in the minority. The majority of responses exhibited the following weaknesses:

- Inability to draw and label a load bearing or non-load bearing wall.
- Lack of knowledge of the correct foundation to draw
- Inability to sketch an orthographic section proportionally

The mean mark for this question was 9.3, with eight per cent of candidates earning full marks. Thirty per cent of candidates scored zero. The unpopularity of the question and high percentage of candidates who scored zero indicate that this topic needs attention in the classroom. It is essential in building drawing practice that students understand the differences between a load bearing and a non-load bearing wall and possess the practical ability to appropriately use well-proportioned orthographic sketches to show the differences.

#### **Recommendations for teachers**

Attention must be given to all aspects of the syllabus.

- There was a general weakness in drawing construction details, especially roof details. Emphasis should be placed on the correct positioning and naming of construction members.
- Sketching appears to be an area of weakness and students should be given more freehand drawing exercises to hone this required skill.
- Students must be reminded to state the title and scale at the base of each drawing.

#### **Paper 032 – Mechanical Engineering Drawing**

This paper comprised two sections: Section I – Assembly Drawing and Section II – Sketch and Design or 3D Solid Model Design Drawing. Section I had two optional questions, each worth 80 marks and Section II had two optional questions, each worth 20 marks. Candidates were required to answer one question from each section. The percentage of candidates earning Grades I–III on Paper 032 for 2013 was 41 per cent compared with 37 per cent for 2012. The mean score on this paper was 42.3 compared with 39.2 for 2012. This represents an improvement in performance on this paper compared with the performance in 2012.

## Section I – Assembly Drawing

### Question 1

Candidates were presented with an enclosed sheet with orthographic details of the parts which make up a Pipe Vice Assembly.

In Part (a), candidates were required to draw in either first-angle or third-angle orthographic projection the following views of the wheeled roller when fully assembled:

- i. A full front section taken on the cutting plane line B – B.
- ii. An elevation looking in the direction of arrow C. They were to show all hidden details for this view.

In Part (b), candidates were required to show six main dimensions, including a length, a diameter, a radius and a metric screw thread specification.

In Part (c), candidates were to print the title *Pipe Vice Assembly* and the scale used as well as show the projection method used by symbol.

Most candidates who attempted this question, demonstrated reasonably good knowledge, understanding and practical ability with regard to the positioning and alignment of views in relation to the orthographic projection method used. Students who used Computer Aided Drawing (CAD) software and printed the solution on one page displayed general knowledge, understanding and practical ability of the alignment and positioning of views based on the orthographic projection method applied. There were a few instances when the candidates using CAD printed the solution on separate pages. As such, the precise understanding of the orthographic projection aspect of the question could not be determined.

Generally, in assembling the parts, most candidates satisfactorily displayed the knowledge, understanding and practical ability required to assemble the parts to complete the Pipe Vice Assembly adequately. In doing the sectional front elevation, candidates generally displayed good knowledge, understanding and practical ability of assembled parts in section. Candidates' handling of a web in section showed significant improvement.

Areas of the question that were not well done include:

- Differentiating between parts with the hatching lines. Candidates' had difficulty differentiating between parts with hatching lines as all or most of the assembly was hatched in one direction or many directions indicating different parts. The main body itself was generally hatched in more than one direction signifying various parts. Special attention and more practice needs to be given to views in section and hatching.
- Representing hidden details of the assembled parts on the end elevation. Although candidates may have drawn the sectional front elevation assembled, a significant percentage of responses showed that they were not clear about how these parts were represented in the outside view.
- Drawing conventions. Conventions such as fillet rounds, screw threads and chamfers were not always well drawn or included on drawings. Special emphasis should be placed on students doing these conventions when practising mechanical drawings in the classroom.

- Drawing of the correct orthographic projection symbol. ‘Correctness’ here not only refers to the relationship with the orthographic views but the positioning of the frustum in relation to the concentric circles which constitute the projection symbol. When drawing the orthographic symbol, the frustum is positioned on the left of the concentric circles to denote first-angle orthographic projection or positioned on the right of the concentric circles to denote third angle orthographic projection. Moreover, a significantly high percentage of candidates were unable to identify the correct symbol to be placed in relation to their views in either first or third-angle orthographic projection.
- Dimensioning of radii, diameters and metric nuts/bolts/threads. Emphasis needs to be placed on the practice of dimensioning with special reference to the leader lines, the distance of dimension lines from the object, the use of arrow heads for mechanical drawing as well as the features indicated.

The mean mark for this question was 33.5. No candidate earned full marks; however, 12 per cent of candidates earned marks ranging from 60 to 77. Six per cent of the candidates scored zero. This dismal statistic indicates a lack of preparation/readiness for the examination on the part of some candidates.

### Question 2

Candidates were presented with an enclosed sheet with orthographic details of the parts which make up a Mounting Jig Assembly.

In Part (a), candidates were required to draw in either first-angle or third-angle orthographic projection the following views of the Mounting Jig Assembly when fully assembled:

- i. A full sectional front elevation taken on the cutting plane line A – A (an offset section).
- ii. An end elevation looking in the direction of the arrow B.

In Part (b), candidates were required to show six main dimensions, including a length, a diameter, a radius and a metric screw thread specification.

In Part (c), candidates were to print the title *Mounting Jig Assembly* and the scale used as well as show the projection method used, by symbol.

Most candidates demonstrated reasonably good knowledge, understanding and practical ability with regard to the positioning and alignment of views in relation to the orthographic projection method used. In instances where the candidates used CAD, they demonstrated adequate knowledge, understanding and practical ability of the alignment and positioning of views based on the orthographic projection method applied despite having incomplete solutions. However, some of these candidates had to rescale the drawings for printing purposes so that the views could fit on one page.

A majority of candidates attempting this question were able to assemble the body to the base. However, candidates had difficulty determining whether the spindle to secure these two parts was to be inserted from the bottom or top of the body. Despite the sectional elevation being offset, the sectional elevation produced by most candidates was in keeping with what was required of the question.

Areas of the question that was not well done include:

- Differentiating between parts with hatching lines. Candidates' had difficulty differentiating between parts with hatching lines as all or most of the assembly was hatched in one direction or many directions indicating different parts. The main body itself was generally hatched in more than one direction signifying various parts. Special attention and more practice needs to be given to views in section and hatching.
- Representing hidden details of the assembled parts on the end elevation. Although candidates may have drawn the sectional front elevation assembled, a significant percentage of responses showed that they were not clear about how these parts were represented in the outside view.
- Drawing conventions. Conventions such as fillet rounds, screw threading, knurling and chamfers were not always well drawn or were omitted from the drawing. Special emphasis should be placed on students doing these conventions when practising mechanical drawings in the classroom. Additionally, there was a lack of other conventions such as centre and construction lines in most of the responses.
- Drawing of the correct orthographic projection symbol. 'Correctness' here not only refers to the relationship with the orthographic views but the positioning of the frustum in relation to the concentric circles which constitute the projection symbol. When drawing the orthographic symbol, the frustum is positioned on the left of the concentric circles to denote first angle orthographic projection or positioned on the right of the concentric circles to denote third angle orthographic projection. Moreover, a significantly high percentage of candidates could not identify the correct symbol to be placed in relation to their views in first or third angle orthographic projection.
- Dimensioning of radii, diameters and metric nuts/bolts/threads. Emphasis needs to be placed on the practice of dimensioning with special reference to the leader lines, the distance of dimension lines from the object, the use of arrow heads for mechanical drawing as well as the features indicated.

The mean mark for this question was 36.8. No candidate earned full marks; however, 11 per cent of the candidates earned marks ranging from 60 to 79. Five per cent of the candidates who attempted this question scored zero. This dismal statistic indicates a lack of preparation/readiness for the examination on the part of some candidates.

## **Section II – Sketch and Design OR 3D Solid Model Design Drawing**

### Question 3

This question tested candidates' ability to interpret the given orthographic views of a bearing bracket to produce a full size, isometric drawing with 'S' as its lowest point.

Generally, candidates demonstrated the ability to interpret the orthographic views presented to produce an assembled isometric sketch with 'S' as the lowest point. Some candidates ably produced the required isometric circles and arcs.

Areas of weakness included:

- Candidates' inability to demonstrate good practical skills in sketching isometric curves and circles. Some candidates had challenges completing these accurately even though knowledge of drawing isometric curves and circles was evident. Also, candidates using CAD in most cases did not indicate construction details for isometric circles and arcs.
- Some candidates were unable to properly centre the cylinder on the webs.

This was the more popular of the two questions in this section. The mean mark for this question was 9.7, with four per cent of the candidates earning full marks. In contrast, 20 per cent of candidates who attempted the question scored zero. This dismal statistic indicates a lack of preparation/readiness for the examination on the part of some candidates.

#### Question 4

This question tested candidates' ability to make neat, well-proportioned orthographic sketches to illustrate the following types of sections:

- i. Removed
- ii. Revolved
- iii. Part
- iv. Half

General performance on this question ranged from satisfactory to poor, the question was not popular. Stronger candidates showed adequate knowledge of the types of sections and the practicality of their uses. They presented well-proportioned, orthographic sketches illustrating the types of sections. Weaker candidates demonstrated very little or no knowledge of the types of sections.

This was the least popular of the two questions in this section. The mean mark for this question was 6.3, with 10 per cent of the candidates earning full marks. Forty-nine per cent of candidates who attempted the question scored zero. This dismal statistic indicates a lack of preparation/readiness for this component of the examination on the part of some candidates. Attention is drawn to Unit 3, Module IV.1 of the syllabus which covers sections.

#### **Recommendation to Teachers**

- Emphasis must be placed on identifying and illustrating the uses of all types of sections.
- Interpretation of instructions given in questions must be given consideration. Students need to be taught how to extract information, interpret such and produce the required product.

#### **Paper 040 – School Based Assessment (SBA)**

The samples selected for this year's SBA marking exercise showed an improvement in the quality of work produced by students. This therefore indicates that the feedback given to teachers has been helpful in allowing them to properly select problems and administer the SBA aspect of the examination.

Although the standard of work submitted has improved, a few points need to be re-emphasized:

- Drawings presented should truly test the ability of students to reason and solve a problem which has been presented.
- Articles such as door wedges, metal straps, table top covers, tissue holders, angle brackets etc. do not constitute a proper CXC project and therefore it is recommended that these not be used as projects. (They do not fully test the skill competencies required of students at the CSEC level nor do they meet the criteria set out in the mark schemes).
- The SBA should test a similar range of skills needed for writing the examination. The knowledge gained from working on the SBA should greatly assist students when answering Paper 3 of the CSEC examination.

### Problem Statement

SBA problem statements should clearly state what the student is required to produce from information which is given. The problem statement should also state specifically what the student is expected to do so that there is no ambiguity when producing what is required (attempting to solve the problem) and should conform to the items listed in the mark scheme.

### Engineering Drawing

Designs should be fully functional. Students should make sure that the parts being assembled show clearly the methods by which parts are attached.

Sectional views should show clearly the solution to the problem being solved. This includes assembled parts and the methods of assembly, for example, the use of nuts, bolts and other locking devices.

### Sectional Elevations

With respect to building drawings, sections through the building should clearly show foundation detail, roof detail and details of wall structures.

### Submission of Problem Statements and Mark Schemes

As stated previously, teachers are expected to make sure that each student's folder contains information on the problem being solved (problem statement, conditions and justifications). Teachers should also submit the CXC mark scheme, clearly showing how marks were awarded to each student in the categories of knowledge, application and practical ability.

It is suggested that all teachers use the same marking instrument; this will allow consistency in the marking of the SBA. To this end, the proposed CXC mark scheme for Building Drawing has been recommended for use.

Teachers should also make sure that drawings are produced using an appropriate scale. The type of construction must be in keeping with the size of the structure being constructed. The maximum size being 200m.<sup>2</sup>

**CARIBBEAN EXAMINATIONS COUNCIL**

**REPORT ON CANDIDATES' WORK IN THE  
CARIBBEAN SECONDARY EDUCATION CERTIFICATE® EXAMINATION**

**MAY/JUNE 2014**

**TECHNICAL DRAWING**

**TECHNICAL PROFICIENCY EXAMINATION**

**Copyright© 2014 Caribbean Examinations Council  
St Michael, Barbados  
All rights reserved.**

## GENERAL COMMENTS

There was an increase in the number of entries from 9 162 in 2013 to 9 622 in 2014. An analysis of the data indicated an increase from the previous overall distribution of Grades I, II and III from 74.39 per cent in 2013 to 78.61 per cent in 2014.

Improvements in candidates' performance in Papers 01, 02, 031 and 04 contributed to the overall increase in performance. Paper 032 showed a slight decrease in performance.

While candidate responses displayed greater content knowledge and application, their practical ability skills require significant improvement, especially in Paper 031. Consequently, the marks allocated to the practical aspects such as presentation, line work and labelling, contributed to a reduction of their overall performance.

## DETAILED COMMENTS

### Paper 01 – Multiple Choice

This paper consisted of 60 multiple-choice questions, testing the profile dimensions of Knowledge (Profile 1), Application (Profile 2), and Practical Ability (Profile 3). The mean score of 35.54 was very consistent with candidates' performance on the paper over the previous 2 years.

## DETAILED COMMENTS

### Paper 02 – Plane and Solid Geometry

#### Section I – Plane Geometry

##### Question 1

This question was designed to test candidates' ability to construct:

- a) a rectangle ABCD, that has a diagonal of 150 mm and the length of one side = 70 mm.
- b) an ellipse within the rectangle with the major axis equal to the length and minor axis equal to the width of the given figure.

Generally, candidates who attempted this question (part a) demonstrated knowledge of a rectangle and therefore were able to construct the rectangle from the given data, and also construct an ellipse (part b) inside the rectangle.

However, some candidates demonstrated lack of knowledge of the diagonal by making the side 150mm, and also to construct an ellipse inside the rectangle. (Any suitable method of ellipse was accepted).

##### Question 2

Candidates were presented with an irregular polygon ABCDE with BC=40 mm, AE=60 mm, CD=75 mm and ED=45 mm.

Candidates were required to construct:

- a) the given irregular polygon
- b) a similar figure with its base AB increased from 50 mm to 70 mm.

Generally, candidates who attempted this question demonstrated good knowledge of constructing the given figure and therefore, were able to construct it. However, some candidates demonstrated lack of knowledge of the principles of similar figures when sides are LINEAR increased.



### Question 3

Candidates were presented with a diagram showing a template of a metal cutter and were required to:

- a) Draw the given template showing clearly how the following are obtained:
  - (i) The centres for arcs A and B
  - (ii) The straight line from point 'P'
- b) Identify EACH point of tangency with a 'DOT'.

Generally, candidates who attempted this question demonstrated a good grasp in reproducing the given circles, the hexagon and the straight line.

However, some candidates demonstrated lack of knowledge of the construction for obtaining the centres for the required two arcs (A and B) and identifying the points of tangency.

### Question 4

In this question, candidates were presented with a figure showing a crank mechanism in which OA revolves clockwise about O. The end, B, of the rod AB is constrained to move horizontally along XY.

This question was designed to test candidates' ability to:

- a) Copy the given mechanism
- b) Plot the locus of P for one revolution of OA.

Generally, candidates who attempted this question demonstrated a good grasp in copying the given mechanism. However, some candidates demonstrated a lack of knowledge and understanding of the movement of the mechanism along the given XY line and were unable to plot the locus of P.

### Question 5

Candidates were presented with the end elevation and an incomplete front elevation of a cylinder intersecting a triangular prism.

This question was designed to test candidates' ability to construct:

- a) the given end elevation
- b) the front elevation showing the curves of interpenetration. Show hidden details.

Generally, candidates who attempted the question demonstrated good knowledge and understanding of constructing the given end elevation and drawing the front elevation.

However, some candidates demonstrated limited knowledge of the interpenetration of a cylinder and a prism and therefore were unable to complete the front elevation with the curve of interpenetration.

### Question 6

Candidates were presented with a figure showing the elevation of two square sheet metal pipes A and B intersecting each other at  $45^\circ$ . This question was designed to test candidates' ability to:

- a) Copy the given view.
- b) Construct the development of pipe A' using the seam as shown on the given view.

Generally, candidates who attempted this question demonstrated some knowledge of drawing the given view and were able to complete the development. However, some candidates demonstrated lack of knowledge and understanding of drawing the two pipes and constructing the development of a square prism (pipe A) with the given seam.

### Question 7

Candidates were presented with the plan and elevation in orthographic projection of a truncated hexagonal prism to draw:

- a) the given views
- b) an auxiliary elevation on  $X^1Y^1$ .

Generally, candidates who attempted this question demonstrated good knowledge of drawing the given views. However, some candidates demonstrated limited knowledge of projecting the auxiliary elevation on the given  $X^1Y^1$  line.

### Question 8

In this question, candidates were presented with a figure showing two orthographic views of a location bracket. Candidates were NOT required to copy these views.

This question was designed to test candidates' ability to draw an isometric view of the bracket with 'X' as its lowest point.

Generally, candidates who attempted the question demonstrated good knowledge of the principles of isometric for drawing the Bracket with 'X' as its lowest point. However, some candidates interpret the views as being in 3<sup>rd</sup> angle projection and therefore use the bottom view as the elevation. The construction of isometric circles seemed to have been a challenge to some candidates.

## **NOTES TO TEACHERS**

In respect to Paper 02, teachers should focus on the specific objectives of the syllabus, to ensure that their students are well prepared for the Geometry in Technical Drawing.

## **Paper 031 – Building Drawing**

### **Section I – Working Drawing**

#### Question 1

Candidates were presented with the outline of a floor plan for a concrete-block constructed office. They were also presented with a site plan drawing with an outline of the building and sewage disposal components.

Part (a) candidates were required to draw at a scale of 1:50, a working drawing floor plan of the building. The working drawing was to include the following:

- i. internal and external wall thicknesses
- ii. all doors and windows
- iii. reception counter
- iv. kitchen appliances, cupboards, and cabinets for a staff room.
- v. bathroom fixtures (toilet and hand basin)
- vi. names of rooms and,
- vii. 10 important dimensions

In Part (b) candidates were required to draw the site plan to a scale of 1:100. The completed drawing was to show the following:

- i. proposed building profile
- ii. setbacks
- iii. driveway, walkway and parking spaces
- iv. sewage disposal including connections for septic tank and soakaway
- v. dimensions of the property line and,
- vi. a north arrow

Both parts were to use standard drawing practices and conventions for producing working drawing floor plans and site plans. A suitable title and scale were to be printed at the base of each drawing. Specifications for all relevant components were provided and candidates were allowed to use their discretion for dimensions not given.

This question was attempted by the majority of the candidates and it is the view of the examiners that this may be due to the heavy focus in the classroom on floor plans during preparation for the examination.

Many of the candidates who attempted part (a) of the question demonstrated the appropriate knowledge of floor plans and successfully applied this knowledge to the production of the drawing. This proficiency was shown in the drawing of a floor plan to 1:50, drawing internal and external walls, labeling rooms, attempts at dimensioning, indication of windows and doors. Weaker candidates did not follow specifications for wall thickness, doors or windows and also had difficulties representing the internal and external walls in the drawing resulting in inconsistent sizes, single lines or drawings not to scale.

While candidates drew the lines required to assemble the drawing, basic aspects of a conventional floor plan were not satisfactorily drawn as several candidates seemed to have difficulty with the following:

- using thick lines and thin lines to differentiate between cut objects (walls) and objects in elevation (window sills, cupboards etc.)
- drawing bathroom and kitchen fixtures to scale – *In most cases these were drawn undersized and incorrectly placed, thereby making them impractical.*
- representing of windows – *In some case, windows were larger than specifications or wall thickness. Windows used the wrong symbol or simply failed to show the difference between window and wall.*

In part (b) of the question, stronger candidates responded as asked and added missing information and applied conventions for site plan drawings. Weaker candidates reproduced the given diagram exactly and to scale without any additions. It was therefore, in this case, difficult to determine knowledge of the drawing type. Candidates on the whole had difficulty with the following:

- using different line types to communicate in the drawing (dash lines, thick lines, thin lines, hatching etc.)
- drawing the requested waste water and sewage disposal diagram for the site. It should be noted that this is a part of the syllabus (II.II.2)
- laying out driveways adequately with the right size for curves and driving areas.

General aspects of weakness in question 1 were the quality of drawings (line work and line type not properly done), labelling (text was unreadable, not straight, varied sizes), dimensioning techniques (dimensions did not connect to lines properly, orientation, accuracy, inconsistency in arrows/ticks) and the omission of the printed title and scale used as required by the question.

In producing the drawings for this question, most candidates did not adhere to the principles of good working drawing practice (as outlined in the weaknesses above). This is cause for serious concern. **Teachers are reminded that this is the "working drawing" section of the examination. As such,**

**standard practices and conventions for completing working drawings are to be rigorously followed.** Emphasis should be placed on line thickness; drawing correct symbols on the appropriate drawings; dimensioning where it concerns extension and dimension lines and the placing and size of the dimension.

### Question 2

In this question candidates were presented with a floor plan outline for a two bedroom house. An outline of the roof was shown on the diagram.

In Part (a), candidates were required to draw a roof framing plan to a scale of 1:50. Candidates were to use a single line to represent the framing members. The roof framing plan was to include the following members:

- i. ridge
- ii. hip rafters
- iii. jack rafters
- iv. valley rafters
- v. common rafters
- vi. fascia board

Candidates were further asked to label all roof members and show the building outline.

In Part (b) candidates were asked to draw to a scale of 1:50, two elevations of the building indicated on the outline by arrows “view 1” and “view 2”. The elevation drawings were to include the following:

- i. all door and window positions
- ii. columns and,
- iii. roof design

A suitable title and scale were to be printed at the base of each drawing. Specifications for all construction elements were provided. Candidates were also given discretionary judgment for dimensions not given. As with question 1, standard drawing practices and conventions for drawing roof framing plans and elevations were to be followed.

Most of the candidates that attempted this question did well in their attempt. Knowledge was demonstrated in the drawing of the building outline and roof edge. The drawing of an initial framing plan by candidates also indicated some limited knowledge of a framing plan.

Examiners however, discovered that candidates were unsure of some roofing details as most were unable to properly identify and label roof members correctly.

In the second part of the question, candidates demonstrated adequate knowledge of elevations in the placing of doors and windows. Some candidates seemed to experience difficulty in interpreting and developing the required elevations for the building from the roof framing plan.

The following are characteristics of weak submissions:

- door and windows did not line up at beam level.
- fascia board omitted from drawing
- ground line not drawn.
- patio with columns were left out of drawing.
- panel door and louver windows were drawn incorrectly or not at all.
- candidates were unable to accurately measure the given distance from wall plate to top of ridge board.

Other aspects of weakness were as in question 1, that is, the quality of drawing, labeling, dimensioning techniques and the omission of the printed title and scale used as required by the question. Teachers are

reminded that standard practices and conventions for completing working drawings are to be rigorously followed.

### **Sketch and Design or 3D Solid Model Design Drawing**

#### Question 3

Candidates were required to make neat well-proportioned three dimensional/pictorial sketches to show the difference between a reinforced concrete stair and a timber stair, labelling the differences clearly.

This question was the least popular in section 2. The majority of the candidates managed to draw pictorial images of stairs/steps. However proportion was not consistent or well executed. Candidates in the majority demonstrated limited knowledge of the major differences between the two types of stairs beyond the fact that one was made of concrete and the other was made of wood. As such, candidates drew the same form and simply added the material symbol for concrete or timber.

Attention must be given to ALL aspects of the syllabus. Sketching in proportion (*II.I.4 in the syllabus*) appears to be an area of weakness.

#### Question 4

Candidates were presented with the outline of a wall section for a house. They were required to make a neat well-proportioned section sketch of the foundation and floor detail indicated in the given image. The question further required the identification, through labeling and material representation, of the following elements:

- i. R.C. strip footing
- ii. 100mm R.C. slab
- iii. 200mm hardcore
- iv. 300mm ceramic tiles
- v. foundation wall

Candidates proportionally drew the required elements for the question. In most cases the proper convention (e.g. line weight, material symbols) for section detail was not shown. Regrettably, a large number of candidates did not correctly identify the drawn elements. This indicated limited knowledge of the elements that comprised a floor and foundation detail. It should be noted that preparing sketches for concrete foundations of buildings is included in the syllabus (II.III.2)

### **Notes to Teachers**

Attention must be given to ALL aspects of the syllabus.

There was a general weakness in drawing construction details especially foundation and stair details. Emphasis should be placed on teaching details including the correct positioning and naming of construction members.

Sketching appears to be an area of weakness and students should be given more freehand drawing exercises to hone this required skill.

Students must be reminded to state the title and scale at the base of each drawing.

Generally throughout the paper, it should be noted that Technical Drawing (according to the syllabus) is a language of communication and as such the strict adherence to convention and basic principles are as important as diction and grammar in other languages. Students should be taught the value of conforming to established drawing standards in order for their drawings to be clear and unambiguous.

## Paper 032 – Mechanical Engineering Drawing

### Section I – Assembly Drawing

#### Question 1

Candidates were presented with an enclosed sheet with orthographic details of the parts which made up a “**Movable Arm Assembly**”.

In Part (a), candidates were required to draw full size in either first-angle or third-angle orthographic project the following views of the Movable Arm when fully assembled:

- i. A plan showing all hidden details.
- ii. A sectional front elevation taken on cutting plane “XX”.

In Part (b), candidates were required to show six main dimensions, including a length, a diameter, a radius and a metric screw thread specification.

In Part (c), the candidate was to print the title ‘Movable Arm Assembly’ and the scale used, as well as show the projection method used, *by symbol*.

The majority of candidates who did the Mechanical Drawing option attempted this question. Most candidates attempting this question, demonstrated reasonably good knowledge; understanding and practical ability with regards to the positioning and alignment of views in relation to the orthographic projection method used. Students who used CAD software and printed the solution on one page displayed a general knowledge, understanding and practical ability of the alignment and positioning of views based on the orthographic projection method applied. There were a few instances when the candidates using Computer Aided Drawing (CAD) printed the solution on separate pages. As such, the precise understanding of this aspect of the question could not be determined.

In assembling the parts, candidates attempting this question displayed a satisfactory understanding of the instructions to interpret and display knowledge, understanding and practical ability required to assemble the parts to complete the Movable Arm Assembly adequately. However, those candidates also displayed hidden details for the plan which further reflected their understanding of the assembly of parts.

Some of the responses were a simple reproduction of the plan as given in the question as opposed to an assembled view which was required and, an outside elevation of the assembled parts with no hatching.

In doing the sectional front elevation, part (a) (ii) candidates generally displayed a fair knowledge, understanding and practical ability of assembled parts in section. The execution of the actual sectional assembly still presented difficulty in terms of accuracy and conventional representation. However, some candidates demonstrated the understanding of the convention of a web in section.

The conventional representation for the cutting plane, orthographic symbol and printing of title and scale of the drawing were aspects that were well done by a greater majority of the candidates.

Areas of the question that were not well done include:

- Candidates’ ability to differentiate between parts with hatching lines as all or most of the assembly was hatched all in one direction or many directions indicating different parts. *Special attention and more practice need to be given with regards to views in section and hatching.*
- Printing of the solutions for candidates doing the examination using CAD software: drawings are not printed to the given scale. In many cases the drawings were printed at a significantly reduced scale or out of scale. Many drawings were scaled so small that marking these scripts became complex. Additionally, some CAD drawings were printed so that the views were separated making it difficult to determine students’ knowledge and understanding of orthographic alignment of views.

*It is recommended that printing of solutions should be done with the CAD teacher present (**ONLY printing**) or the Technical drawing teacher should set the parameters for printing on whichever drawing sheets would be used to submit solutions **PRIOR** to the examination.*

- Emphasis needs to be placed on the practice of dimensioning with special reference to the leader lines, the distance of dimension lines from the object, the use of arrow heads for mechanical drawing as well as the features indicated.

Attention is drawn to:

- Interpretation of instructions given in the questions. Students need to be taught how to extract information, interpret such and produce the required product.

## Question 2

Candidates were presented with an enclosed sheet with orthographic details of the parts which made up a **“Handle Control Assembly”**.

In Part (a), candidates were required to draw in either first-angle or third-angle orthographic project the following views of the machine vice when fully assembled:

- i. A front elevation showing hidden details.
- ii. A sectional end elevation taken on the cutting plane “YY”.

In Part (b), candidates were required to show six main dimensions, including a length, a diameter, a radius and a metric screw thread specification.

In Part (c), the candidate was to print the title ‘Handle Control Assembly’ and the scale used as well as show the projection method used, by symbol.

Fewer candidates attempted this question and demonstrated reasonably good knowledge; understanding and practical ability with regards to the positioning and alignment of views in relation to the orthographic projection method used. A greater percentage of candidates attempting this question were able to assemble the handle to the body. However, candidates had difficulty positioning the pivot pin; wing nut and bolt as given in the assembly instructions. The representation of the wing nut itself and the nut were well done.

The sectional assembled elevation seemed to challenge the vast majority of candidates responding to this question. Candidates’ had difficulty differentiating between parts with hatching lines as well as conventions in section. Special attention and more practice need to be given with regards to views in section and hatching.

In the instances when the candidates used Computer Aided Drawing (CAD) they demonstrated adequate knowledge, understanding and practical ability of the alignment and positioning of views based on the orthographic projection method applied despite having incomplete solutions. However, some of these candidates had to rescale the drawings for printing purposes so that the views may fit on one page.

Areas of the question that were not well done include:

- Conventions such as fillet rounds, screw threading, knurling and chamfers which were not well drawn or were left out of the drawing. Special emphasis should be placed on students doing these conventions when practising mechanical drawings in the classroom. Additionally there was a distinct lack of other conventions such as centre and construction lines in most of the responses.
- Dimensioning of radii, diameters and metric nuts/bolts/threading. Emphasis needs to be placed on the practice of dimensioning with special reference to the leader lines, the distance of dimension lines from the object, the use of arrow heads for mechanical drawing as well as the features indicated.

Attention is drawn to:

- Interpretation of instructions given in the questions. Students need to be taught how to extract information, interpret such and produce the required product.

### **Sketch and Design OR 3D Solid Model Design Drawing**

#### Question 3

This question tested candidates' ability to interpret the given orthographic views of a tool block to produce a well-proportioned oblique sketch. A significant number of the candidates registered for Mechanical option responded to this question.

Generally, candidates who attempted this question demonstrated the ability to interpret the orthographic views to produce a 3D drawing. However, only about half of the candidates produced an oblique sketch of the tool block with the rest producing various solutions in isometric projection.

Areas of weakness included:

- Inability of the candidates to follow the principles of oblique drawing and the position of the true face.

#### Question 4

This question tested candidates' ability to make neat, well-proportioned orthographic sketches to illustrate three of the following types of sections:

- (a) Counterbore
- (b) Countersunk
- (c) Internal screw threads
- (d) Blind tapped hole
- (e) Through tapped hole

Fewer candidates responded to this question. Of the candidates' who answered this question, most demonstrated a fair knowledge of the conventions but had difficulty showing the representation in section. However, the few candidates who showed an adequate knowledge of these also presented well-proportioned, orthographic sectional sketches of the conventions.

- Emphasis needs to be placed on drawing these conventional symbols and more specifically in section.

### **School Based Assessment**

The samples selected for this year's 2014 SBA marking exercise once again showed an improvement in the quality of work produced by the students. This therefore indicates that teachers have found the feedback from the moderators to be helpful.

Although the standard of work submitted has improved, the SBA team would still however like to reemphasize a few points:

#### Selection of SBA Problems

The problems to be solved for the SBA component should be of the type which would prepare the student to answer questions from the actual CSEC examination paper. The knowledge gained from working on the SBA would greatly assist the student when answering Paper 03 of the CSEC examination. There should be a direct correlation between what is done by the student for the SBA and what will be required in the exam.

Students should therefore be guided and instructed on focusing on those areas which will be presented in the exam when working on problems for their SBAs.



### Research of Projects

Research should be conducted on items such as springs, plungers and levers. How they are assembled and how they should function would definitely assist the student in producing a drawing clearly showing the method of assembly and how the device (mechanism) should work.

### Dimensioning

There are still some areas which need to be worked on. For example some students are still not correctly dimensioning their projects. Drawings should be drawn to a scale with the true (actual) measurement stated. It is very important that the scale used be stated.

Sectional detail of drawings.

In instances where an object has many component parts, as much detail as possible should be shown. Parts should be individually sectioned.

### Problems

The solutions presented should answer the problem which was stated. The main focus should be to produce drawings which show the solution to the specific problem.

For example, rain water is settling on a parapet roof and as a result water is dripping through and damaging the ceiling below. The solution should therefore be to find ways in which the water can be drained from the roof. Emphasis should be placed on methods of drainage. The use of guttering and down pipes should be employed in the solution showing how the water is being diverted off the roof.

If the problem also stipulates that a new roof is required, detailed drawings showing the type of roof to be constructed (including roof framing plan and how it is to be secured of the existing structure must be included.

Your solution should not just be basic elevations and pictorial view of the building. As stated above greater detail would be required.

### Submission of Problem Statements and Mark Schemes

The problem statement should clearly state what the student is required to produce from information which is given. State specifically what the student is expected to do so that there is no ambiguity when producing what is required (attempting to solve the problem).

As stated before, teachers are expected to make sure that each student's folder contains information on the problem being solved (problem statement, conditions and justifications). Also submit the CXC mark scheme clearly showing how marks were awarded to each student in the categories of knowledge, application and practical ability.

The use of CXC's mark scheme is strongly advised. There can be a deviation from the correct marks which are to be awarded, if this not done.

The Moderation Feedback Sheet on the SBA is used as an indication as to how the teacher has assessed the student's work and how the students have solved the problems for the SBA. *PLEASE TAKE NOTE OF THE COMMENTS WHICH HAVE BEEN MADE BY THE EXAMINERS AND ACT ACCORDINGLY*

**CARIBBEAN EXAMINATIONS COUNCIL**

**REPORT ON CANDIDATES' WORK IN THE  
CARIBBEAN SECONDARY EDUCATION CERTIFICATE® EXAMINATION**

**MAY/JUNE 2015**

**TECHNICAL DRAWING  
TECHNICAL PROFICIENCY EXAMINATION**

**Copyright© 2015 Caribbean Examinations Council  
St Michael, Barbados  
All rights reserved.**

## GENERAL COMMENTS

There was a decrease in the number of entries from 9622 in 2014 to 9416 in 2015. An analysis of the data indicated a decrease from the previous overall distribution of Grades I, II and III from 78.61 per cent in 2014 to 62.95 per cent in 2015.

There was consistency in candidates' performance on Papers 01, 032 and 04, but a decline in performance on Papers 02 and 031 contributed to the overall decrease in performance.

Candidates' responses displayed decreased content knowledge, application, and practical ability skills, especially in Paper 031. Poor responses to questions related to foundation plans, roof plans, and windows types contributed to a reduction in their overall performance.

## DETAILED COMMENTS

### Paper 01 – Multiple Choice

This paper consisted of 60 multiple-choice questions, testing the profile dimensions of Knowledge (Profile 1), Application (Profile 2), and Practical Ability (Profile 3). The mean score of 35.29 was very consistent with candidates' performance on the paper over the previous 2 years.

### Paper 02 – Plane and Solid Geometry

#### Section I – Plane Geometry

##### Question 1

Candidates were required to construct the largest possible regular heptagon within a circle of diameter 110 mm.

This question was designed to test candidates' ability to construct a regular seven-sided polygon given the diameter of its circumscribing circle.

The question was very popular with candidates, most of whom accurately produced the circle given its diameter, as well as demonstrated knowledge of a heptagon.

However, the construction of a regular heptagon within a given circle posed significant problems to most candidates, some who seemed unfamiliar with the properties of a regular polygon or how to accurately obtain one.

##### Question 2

Candidates were presented with the outline of a quadrilateral ABCD, Figure 1, with sides AB and BC of lengths 70 mm and 80 mm, respectively; internal angles ABC and BAD equal to  $60^\circ$  and  $90^\circ$ , respectively; and an external angle of  $45^\circ$  at C.

Candidates were required to construct:

- The given figure
- A rectangle equal in area to the given quadrilateral ABCD.

This question was the most popular plane geometry question, particularly Part (a). Candidates who attempted it did so, generally, with fair success, and demonstrated some knowledge of obtaining a quadrilateral from the given data.

However, candidates demonstrated limited knowledge of transitioning from the given figure to the required rectangle of equal area.

### Question 3

Candidates were given the outline of a hair brush, Figure 2, fully dimensioned, to be accurately reproduced with adherence to the principles of tangency.

This question was designed to test candidates' ability to:

- Blend lines and curves (arcs).
- Locate and clearly indicate all points of tangency on the hair brush.

Candidates accurately reproduced the given hair brush's centre lines and straight lines.

However, the question was unpopular with most candidates. Further, candidates who attempted this question demonstrated limited ability in the application of the principles of tangency as reflected by their poor lack of constructions for obtaining and identifying the points of tangency.

### Question 4

Candidates were presented with a diagram AOBC, Figure 3, representative of a Link Mechanism. Arm OA, 35 mm long, rotated 360° clockwise about 'O'. Arm BC, 60mm long, clockwise or anticlockwise movement about 'B', was dependent upon the rotation of arm OA. Arms OA and BC, 100 mm c/c, were connected by 'link' AC, 110 mm long with a point 'D' located 60 mm from point 'A'.

The question was designed to test the candidates' ability to:

- Copy the given mechanism.
- Construct the locus of point 'D' for one revolution of link OA.

Candidates who attempted this question demonstrated fair knowledge of link mechanisms as reflected by their representation of the transitory positions of the rotating arm 'OA'.

However, this question was the least popular of this section and most candidates seemed to lack the ability for the higher-order processes necessary for obtaining the temporal positions of rotating arm 'BC' and the link 'AC'. Thus, most candidates did not accurately obtain the locus of point 'D'.

## Section II – Solid Geometry

### Question 5

Candidates were presented with two orthographic views, Figure 4 — the plan and an elevation, of a simple bracket. Candidates were not required to copy these views.

This question was designed to test candidates' ability to produce an isometric drawing of the *simple bracket* with a given point 'P' as its lowest point.

Generally, candidates who attempted this question demonstrated good knowledge and understanding of interpreting the given orthographic views so as to arrive at the appropriate isometric drawing.

However, a large percentage of candidates demonstrated limited knowledge of accurately producing the arcs and circles in isometric projection.

### Question 6

Candidates were presented with Figure 5, two orthographic views — the plan and an incomplete elevation of two hexagonal prisms — with their axes located on the same plane, and intersecting at an angle of  $60^\circ$ .

This question was designed to test candidates' ability to:

- Reproduce the given views.
- Complete the
  - plan view to show the cut surface of the inclined prism.
  - elevation to show the interpenetration of the two prisms.

Generally, candidates who attempted this question accurately reproduced the given views. However, most candidates demonstrated limited knowledge of constructing a hexagon given the across flats (A/F) dimension, instead they constructed the hexagon using the across corners (A/C) method. Additionally, most of these candidates seemed unfamiliar with the procedures associated with obtaining the interpenetration lines of intersecting prisms. Thus, a high percentage of candidates were unable to complete the plan view, and the elevation with the lines of interpenetration.

### Question 7

Candidates were presented with Figure 6 showing two orthographic views depicting the outline of the plan and an elevation of a range hood.

This question was designed to test candidates' ability to:

- Draw the given views.
- Produce the auxiliary plan of the range hood, projected on a given 'X–Y' line, inclined at an angle of  $45^\circ$ .

This question was popular with most candidates who also accurately reproduced the given views and the 'X-Y' line.

Nonetheless, most displayed limited knowledge of auxiliary projection as was evidenced by their attempts to project the required auxiliary plan view from the given orthographic plan view. Moreover, most candidates who accurately attempted the auxiliary plan view seemed unacquainted with related processes for obtaining the circle.

### Question 8

In this question, candidates were presented with Figure 7 showing two orthographic views of a right cone truncated at  $30^\circ$  to the horizontal plane (HP), an elevation indicating the seam 'S-S', and an incomplete plan view.

This question was designed to test candidates' ability to:

- Reproduce the two given views.
- Complete the plan view to accurately obtain the truncated portion of the right cone.
- Produce the development of the truncated right cone with its seam at 'S-S'.

This question was popular with approximately 50 per cent of the candidates, most of whom accurately reproduced the given views, and represented surface lines on the plan. Also, most candidates demonstrated adequate knowledge of producing the development for a right cone.

However, candidates demonstrated limited knowledge of representing surface lines on the elevation and accurately transferring the true lengths of the truncated face onto the development.

On 16 June, an alternative Technical Drawing Paper 02 examination was held for the Guyana candidates since all CXC examinations originally scheduled for 12 May were postponed to facilitate that country's general elections.

Every effort was made to ensure that candidates who sat this alternative Paper 02 were presented with questions, though different from the Technical Drawing Paper 02 sat by candidates on 12 May, having similar measurement and evaluation objectives.

## **Plane Geometry**

### Question 1

Candidates were required to construct the largest possible regular pentagon within a circle of diameter 118 mm.

This question was designed to test candidates' ability to construct a regular five-sided polygon given a circumscribing circle of diameter 118 mm. It was very popular with candidates, most of whom accurately produced a circle given its diameter, as well as demonstrated knowledge of a pentagon.

However, the construction of a regular pentagon within a given circle posed significant problems to most candidates, who seemed unfamiliar with the properties of a regular polygon or how to accurately obtain one.

### Question 2

Candidates were presented with the outline of a quadrilateral ABCD, Figure 1, with sides AB and BC of lengths 100 mm and 40 mm, respectively; internal angles ABC and BAD equal to  $90^\circ$  and  $45^\circ$ , respectively; and an external angle of  $60^\circ$  at C. Candidates were required to construct:

- The given figure
- A rectangle equal in area to the given quadrilateral ABCD.

Generally, Part (a) was quite popular with candidates and they attempted it fairly successfully and demonstrated some knowledge of obtaining a quadrilateral from the given data.

However, candidates demonstrated limited knowledge in transitioning from the given figure to the required rectangle of equal area.

### Question 3

Candidates were given the outline of a hair brush, Figure 2, fully dimensioned, to be accurately reproduced with adherence to the principles of tangency.

This question was designed to test candidates' ability to:

- Accurately blend lines and curves (arcs).
- Locate and clearly indicate all points of tangency on the hair brush.

This question was fairly popular with candidates, most of whom accurately reproduced the centre lines and circle necessary for obtaining the general layout of the hair brush. However, candidates demonstrated limited ability in the application of the principles of tangency as reflected by their lack of constructions necessary for obtaining and identifying the points of tangency.

### Question 4

Candidates were presented with a diagram BOAC, Figure 3, representative of a Link Mechanism. Arm OA, 30 mm long, rotated  $360^\circ$  clockwise about 'O'. Arm BC, 55 mm long, clockwise or anticlockwise rotation about 'B', was dependent upon the rotation of arm OA. Arms OA and BC, 110 mm c/c, were connected by 'link' AC, 100 mm long with a point 'D' located 45 mm from point 'A'.

The question was designed to test candidates' ability to:

- Copy the given mechanism.
- Construct the locus of point 'D' for one clockwise revolution of link OA.

This question was fairly popular with candidates, most of whom accurately reproduced the given figure. However, candidates who attempted this question demonstrated very little knowledge of link mechanisms as reflected by their inability to:

- Produce accurate representations of the transitory positions of the rotating arm 'OA'.
- Demonstrate the higher-order processes necessary for obtaining the temporal positions of rotating arm 'BC' and the link 'AC'. Thus, most candidates did not accurately obtain the locus of point 'D'

## Solid Geometry

### Question 5

Candidates were presented with two orthographic views, Figure 4 – the plan and an elevation of a *simple bracket*. Candidates were not required to copy these views.

This question was designed to test candidates' ability to produce an isometric drawing of the *simple bracket* with a given point 'P' as its lowest point. However, most candidates who attempted this question merely reproduced the given orthographic views, and thereby demonstrated no knowledge or understanding of how to convert the given orthographic views to the appropriate isometric drawing.

It was fairly popular with candidates based on the responses received.

### Question 6

Candidates were presented with Figure 5, two incomplete orthographic views — the plan and an elevation of two hexagonal prisms — with their axes located on the same plane, and intersecting at an angle of  $60^\circ$ .

This question was designed to test candidates' ability to:

- Reproduce the given views.
- Complete the
  - plan view to show the top of the inclined prism.
  - elevation to show the interpenetration of the two prisms.

Generally, candidates who attempted this question accurately reproduced the given views. However, some candidates demonstrated limited knowledge of constructing a hexagon given the across corners (A/C) dimension, instead they constructed the hexagon using the across flats (A/F) method. Also, most candidates seemed unfamiliar with the procedures associated with obtaining the interpenetration lines of intersecting prisms. Thus, candidates were unable to complete the plan view and the elevation with the lines of interpenetration.

### Question 7

Candidates were presented with Figure 6 showing two orthographic views depicting the outline of the plan and an elevation of a range hood.

This question was designed to test candidates' ability to:

- Draw the given views.
- Produce the auxiliary plan of the range hood, projected on a given 'X–Y' line, inclined at an angle of  $60^\circ$ .



This question was popular with a fair number of candidates, who also accurately reproduced the given views and the 'X–Y' line.

Nevertheless, most candidates displayed limited knowledge of auxiliary projection as was evidenced by their poor attempts to project the required auxiliary plan view from the given orthographic plan view, and in particular, their demonstrated inability to accurately obtain the circle.

### Question 8

In this question, candidates were presented with Figure 7 showing two orthographic views of a right cone truncated at  $45^\circ$  to the horizontal plane (HP) — an elevation indicating the seam 'S–S' and an incomplete plan view.

This question was designed to test candidates' ability to:

- Reproduce the two given views.
- Complete the plan view to accurately illustrate the truncated portion of the right cone.
- Produce the development of the truncated right cone with its seam at 'S–S'.

Most candidates accurately reproduced the given views. However, this question was the least popular of the questions in solid geometry attempted by candidates. Also, most candidates demonstrated limited knowledge of how to accurately obtain the division of the circle necessary for the interpretation of the surface lines on the plan view and elevation of the given right cone, and transferring the true lengths of the truncated face onto the development.

### **Recommendations to Teachers**

Teachers are advised to:

- Focus on the specific objectives of each topic of Module 1 of the syllabus to ensure that their students are well prepared for the Geometry in Technical Drawing.
- Demonstrate and have students practice extracting information from geometrical questions to formulate solutions.
- Continually give students questions with diagrams to practice from Module 1 of the syllabus until the final examination.

## Paper 031 – Building Drawing

### Section I – Working Drawing

#### Question 1

Candidates were presented with the outline of a floor plan for a typical cabin in a holiday resort. The cabin consisted of a single bedroom with living area and kitchenette. The roof design was indicated by a broken line on the floor plan diagram.

In Part (a) candidates were required to draw at a scale of 1:50, and using appropriate building conventions, the foundation plan for the building. The foundation consisted of a simple strip footing beneath the building walls and pad footings under the columns. Candidates were also required to:

- Label the important elements on the foundation plan.
- Show ten important dimensions.

In Part (b), candidates were required to draw to a scale of 1:50, and in keeping with standard drawing practices, two elevations of the building looking from the direction of both View 1 and View 2 as indicated on the drawing. The elevation should include:

- Window and door positions
- Roof outline and fascia board
- Clear indication of the ground line
- Three important dimensions

Candidates were to use standard drawing practices and conventions for producing both the foundation plan and elevations. Specifications for all relevant components were provided and candidates were allowed to use their discretion for dimensions not given. A suitable title and scale were to be printed at the base of each drawing.

This question was attempted by 32 per cent of the candidates who undertook the Building Drawing option. Many candidates who attempted Part (a) demonstrated the appropriate knowledge of foundation plans and successfully applied this knowledge to the production of the foundation plan. This proficiency was shown in the drawing of a foundation plan to a scale of 1:50, drawing foundation walls; strip footing; pad footing; labelling important elements and attempts at dimensioning.

Some candidates demonstrated a lack of knowledge of foundation plans by drawing the floor plan. Several candidates seemed to have difficulty with the following:

- Foundation block walls — Floor plan walls were drawn instead.
- Strip footing — in some cases these were represented by bold outlines.
- Pad footing — in most cases there was none drawn in the solutions.

In the second part of the question, candidates demonstrated adequate knowledge of elevations as evidenced by the placement of doors, windows and the roof design. The weaker candidates appeared

to have experienced difficulty in interpreting and developing the required elevations with the given roof designs for the building. The following are the weaknesses as evidenced by candidates' submissions:

- Doors were not aligned to the measurements on the floor plan.
- The fascia board was omitted from the elevations.
- Ground lines were not indicated.
- Columns were not drawn on responses.

General aspects of weakness in Question 1 were the quality of drawings (line work and line type not properly done), labelling (text was unreadable, not straight, varied sizes), dimensioning techniques (dimensions did not connect to lines properly, orientation, accuracy, inconsistency in arrows/ticks) and the omission of the printed title and scale used as required by the question.

Teachers are reminded that this is the *working drawing* section of the examination. As such, standard practices and conventions for completing working drawings are to be rigorously followed. Emphasis should be placed on line thickness; drawing correct symbols on the appropriate drawings; dimensioning where it concerns extension and dimension lines and the placing and size of the dimension.

### Question 2

In this question candidates were presented with the outline of a floor plan for a typical cabin in a holiday resort. The cabin consisted of a single bedroom with living area and kitchenette. It extended onto a verandah with suspended hardwood floor.

Part (a) required candidates to draw to a scale of 1:50, using appropriate conventions, a working drawing floor plan of the cabin. The drawing was to include:

- Internal and external walls
- All windows and doors
- Kitchen appliances, cupboards and cabinets
- Bathroom fixtures
- Names for all rooms
- Ten important dimensions (interior and exterior) to include overall building dimensions; room dimensions; openings and wall change in direction

In Part (b), candidates were asked to draw to a scale of 1:50, the sectional detail on 'B-B' as indicated on the given outline of the floor plan, to show details of the concrete floor and the suspended timber floor. They were to clearly label and dimension the construction components.

Both parts of the question required the use of standard drawing practices and conventions for producing the working drawing floor plans and sectional details. A suitable title and scale were to be printed at the base of each drawing. Candidates were also given discretionary judgement for dimensions not given.

Sixty eight per cent of candidates doing the Building Drawing option answered this question which suggests that a heavy focus is placed on floor plan drawing in the classroom. Most of the candidates who attempted this question demonstrated the appropriate knowledge of floor plans and successfully applied this knowledge to producing the floor plan. This was evidenced by drawing the floor plan to a scale of 1:50; drawing internal and external walls; labelling rooms; attempts at dimensioning and the indication of windows and doors. More emphasis needs to be placed on following specifications. A significant number of candidates portrayed weaknesses in representing building walls resulting in inconsistent sizes or single line drawings. In addition, other candidates did not use the given scale and drew their responses 'not-to-scale'.

In the second part of the question, candidates demonstrated adequate knowledge of suspended timber floors by showing a suitable method for constructing the floor joist to the concrete floor. However, a significantly higher percentage of candidates responding to this question merely reproduced the given diagram without displaying any constructions.

The following are characteristics of weak submissions for Part (b):

- Suitable methods for supporting the ends of floor joists in suspended timber floors. Suitable methods that are suggested for use – *sleeper wall, wall bearing or joists hangers*
- Pad foundation — appropriate foundation required for use under columns in verandahs.
- Strip foundation — appropriate foundation suggested for use in solid ground floors of single-storey buildings.

General aspects of weakness observed in Question 2 were:

- The quality of drawing — line work and line types not properly done.
- Labelling — inconsistent sizes, illegible writing, writing not straight.
- Dimensioning techniques — dimensioning lines not accurately indicating the area to be dimensioned, inconsistencies in arrows/ticks.
- Omission of the printed title and scale used as required by the question.

### **Recommendations to Teachers**

Teachers are reminded that this is the working drawing section of the examination, as such standard practices and conventions for completing working drawings are to be rigorously followed.

### **Sketch and Design or 3D Solid Model Design Drawing**

#### Question 3

Candidates were required to make neat well-proportioned three dimensional/pictorial sketches to illustrate the following types of foundation:

- Raft
- Strip
- Pad foundation

Approximately 26 per cent of the candidates responded to this question. The majority of the candidates responding to this question managed to draw pictorial images. However, proportional sketching was not consistent or well executed. Candidates appeared to be able to illustrate the pad and strip foundations, however, the raft foundation does not appear to be well known. The representation for pad foundation was well executed.

Attention must be given to:

- Different types of foundation
- Sketching in proportion (II.I.4 in the syllabus)
- Three-dimensional drawing

#### Question 4

Candidates were required to make neat, well-proportioned sketches, either three dimensionally or in orthographic projection, of three types of windows:

- Casement
- Awning
- Horizontal

Thirty four per cent of the candidates doing the Building Drawing option responded to this question. Of those who attempted this question, awning windows was well represented. Both the casement and sliding windows were well known but not well illustrated. Additionally, candidates did not indicate the direction for sliding using arrows in the sliding windows.

Teachers must note specifically for sketch and design that:

- When students are taught to sketch building details or features *attention must be given to the defining features of the object being sketched*. As in Question 4, a window is defined as a specific type based on its operation, so in the absence of the indicators of operation, it is just a window and does not satisfy the requirements of the question when a request is made for a specific type of window.
- The sketching of building details/objects should be done proportionally.

#### **Further Comments**

Candidates are reminded that all responses must be printed as stated on the question paper.

Attention must be given to all aspects of the syllabus.

There was a general weakness in drawing construction details especially foundation and wooden timber floors. Emphasis should be placed on teaching details including the correct positioning and naming of construction members.

Sketching appears to be an area of weakness and students should be given more freehand drawing exercises to hone this required skill.

Students must be reminded to state the title and scale at the base of each drawing.

## Paper 032 – Mechanical Engineering Drawing

### Section I – Assembly Drawing

#### Question 1

Candidates were presented with an enclosed sheet with orthographic details of the parts which made up a shaft support assembly.

In Part (a), candidates were required to draw full size in either first-angle or third-angle orthographic project the following views of the movable arm when fully assembled:

- A plan showing all hidden details.
- A sectional front elevation taken on cutting plane 'A–A'.

In Part (b), candidates were required to show six main dimensions, including a length, a diameter, a radius and a metric screw thread specification.

In Part (c), candidates were to print the title 'Shaft Support Assembly' and the scale used as well as show the projection method used, by symbol.

Approximately 86 per cent of candidates who did the Mechanical Drawing option attempted this question. Only about 40 per cent of the candidates were able to assemble the components in accordance with stated directions in the question. Those who did this question demonstrated reasonably good knowledge, understanding and practical ability with regard to the positioning and alignment of views in relation to the orthographic projection method used. Approximately a third of the responses were done in 'landscape' thus preventing the views from being aligned correctly. Quite a few candidates using computer-aided drawing (CAD) software and who printed both views on one page displayed general knowledge, understanding and practical ability of the alignment and positioning of views based on the orthographic projection method applied. However, there were some instances when the candidates using (CAD) printed the solution on separate pages. As such, the precise understanding of this aspect of the question could not be determined.

In assembling the parts, approximately 40 per cent of the candidates displayed a satisfactory understanding of the instructions to interpret and display knowledge, understanding and practical ability required to assemble the parts to complete the shaft support assembly adequately. They also displayed hidden details for the plan which further reflected their understanding of the assembly of parts.

About 25 per cent of the responses were a simple reproduction of the plan as given in the question as opposed to an assembled view. In doing the sectional front elevation, approximately 41 per cent of the candidates generally displayed difficulty in assembling the parts to make up the shaft support assembly. The execution of the actual sectional assembly was also lacking in terms of accuracy and conventional representation. A large number of candidates had difficulty in demonstrating the use of cross-hatching lines to differentiate different parts.

Candidates and teachers need to pay particular attention to the following comments which relate to areas of the question that were not well done.

- Candidates' ability to differentiate between parts with hatching lines as all or most of the assembly was hatched all in one direction or many directions indicating different parts. *Special attention and more practice need to be given with regards to views in section and hatching.*
- Printing of the solutions for candidates doing the examination using CAD software: drawings are not printed to the given scale. In many cases the drawings were printed at a significantly reduced scale or out of scale. Many drawings were scaled so small that marking these scripts became complex. Additionally, some CAD drawings were printed so that the views were separated making it difficult to determine candidates' knowledge and understanding of orthographic alignment of views.
- Emphasis needs to be placed on the practice of dimensioning with special reference to the leader lines, the distance of dimension lines from the object, the use of arrow heads for mechanical drawing as well as the features indicated.
- The conventional representation for the cutting plane, orthographic symbol and printing of title and scale of the drawing.
- Interpretation of instructions given in the questions. Students need to be taught how to extract information, interpret such and produce the required product.
- Students need to be taught how to print and manipulate printing specs when drawing with CAD.

### Question 2

Candidates were presented with an enclosed sheet with orthographic details of the parts which made up a milling machine attachment.

In Part (a), candidates were required to draw in either first-angle or third-angle orthographic projection the following views of the machine vice when fully assembled:

- A plan showing hidden details.
- A sectional front elevation taken on the cutting plane 'C-C'.

In Part (b), candidates were required to show six main dimensions, including a length, a diameter, a radius and a metric screw thread specification.

In Part (c), candidates were to print the title 'milling machine attachment' and the scale used as well as show the projection method used, by symbol.

Fourteen per cent of the candidates who did the Mechanical option attempted this question.

Candidates demonstrated reasonably good knowledge, understanding and practical ability with regard to the positioning and alignment of views in relation to the orthographic projection method used. A greater percentage of candidates attempting this question were also able to interpret the instructions to assemble the parts reasonably well. However, a few candidates used the vertical centre line on the

plan of the given milling attachment body for placement, thus resulting in an inaccurate positioning on the base.

Those candidates who attempted the sectional assembled elevation were able to represent the assembled parts in section satisfactorily. Candidates were able to utilize the cross-hatching convention well to differentiate the assembled parts. The representation of metric bolts were well done so too was the treatment of a web in section.

In the instances when candidates used CAD, they demonstrated adequate knowledge, understanding and practical ability of the alignment and positioning of views based on the orthographic projection method applied despite having incomplete solutions. However, some of these candidates had to rescale the drawings for printing purposes so that the views could fit on one page.

Areas of the question that were not well done include:

- Conventions such as centre, cutting plane and construction lines in most of the responses.
- Dimensioning of radii, diameters and metric nuts/bolts/threading. Emphasis needs to be placed on the practice of dimensioning with special reference to the leader lines, the distance of dimension lines from the object, the use of arrow heads for mechanical drawing as well as the features indicated.

Attention is drawn to:

- Interpretation of instructions given in the questions. Students need to be taught how to extract information, interpret such and produce the required product.
- Drawing orthographic projection and the correct positioning/alignment of views.
- Matching the orthographic projection symbol to the projection method used.

### **Sketch and Design OR 3D Solid Model Design Drawing**

#### Question 3

This question tested candidates' ability to interpret the given orthographic views of a cast iron Bracket to produce a well-proportioned isometric sketch with a lowest point 'P'. Sixty four per cent of the candidates who did the Mechanical option responded to this question.

Many candidates who attempted this question demonstrated an inability to interpret the orthographic views to produce the correct isometric drawing. However, those candidates who interpreted and produced the required drawing managed to do so very well and gained more than 50 per cent of the marks. Isometric curves/circles were features that were significantly improved.

Areas of weakness included the inability to:

- Interpret the given orthographic projection views to the required isometric sketch.
- Produce non-isometric lines.



Question 4

This question tested candidates' ability to reproduce neat, well-proportioned sketches of the given orthographic views of a steering wheel and to show the following sections in application:

- Half-section
- Revolved section
- Local section

Approximately 15 per cent of the candidates doing the mechanical option responded to this question. Of the candidates who answered this question, a significant number had difficulty representing the required orthographic sectional views in application. However, the few candidates who showed an adequate knowledge of these also presented well-proportioned, orthographic sectional sketches of the sections.

Emphasis needs to be placed on

- Different types of sections.
- Application of sections
- Sketching proportionally
- Sketching orthographic views.

**Recommendations to Teachers**

Generally throughout the paper, it should be noted that Technical Drawing (according to the syllabus) is a language of communication and as such the strict adherence to the conventions and basic principles are as important as diction and grammar in other languages. Students should be taught the value of conforming to established drawing standards in order for their drawings to be clear and unambiguous.

**Paper 03 – School-Based Assessment (SBA)**

The samples selected for the 2015 SBA marking exercise once again showed an improvement in the quality of work produced by students. This therefore indicates that teachers have found the feedback from the moderators to be helpful.

Although the standard of work submitted has been satisfactory, the SBA team would still, however, like to re-emphasize a few points.

There continues to be too great a disparity between the mark given by the teacher and that of the moderators. Some of the reasons for this stem from the fact that some teachers have not been using the mark scheme provided by CXC but have been creating their own. There is also the case where problems are being submitted which do not meet the criteria at the CSEC level. In such cases this does not enable students to cover aspects of the syllabus.

For example Engineering Drawing students are designing things such as wooden chest of drawers, book cases, drawing tables etc. It is felt that these students should focus on things like engineers' vice, clamps, devices for securing work when drilling, welding, sawing etc.

With respect to the Building Drawing students, emphasis should be placed on topics such as floor plans; elevations and roof framing plans; aspects of designing houses with a number of rooms and improving existing designs etc.

Students should therefore be guided and instructed to focus on those areas which will be presented in the exam when working on problems for their SBAs.

#### Selection of SBA Problems

Once again it is being re-emphasized that the problems to be solved for the SBA component should be of the type which would prepare students to answer questions from the actual CSEC examination paper. The knowledge gained from working on the SBA would greatly assist the student when writing Paper 03 of the CSEC examination. There should be a direct correlation between what is done by the student for the SBA and what will be required in the exam.

Teachers are to be commended for recording and submitting marks on the mark scheme as recommended. Further, most projects were suitable for the category/criteria selected. Generally, the standard of work produced this year was satisfactory.